

HSA-Alt Training Test Paper Response Option Training Materials

Grade 11 ELA, Mathematics and Science

This document contains the paper response option cards and paper test visuals for use with the HSA-Alt Training Tests in ELA, Mathematics, and Science for Grade 11.

To practice using the paper response option cards and paper test visuals with a student who will be using this format for the operational testing, print this entire document using the two-sided print settings on your printer. The test name, grade level, and corresponding item number will then be printed on the back of each page.

Notes: Not all training test items will have a corresponding printed test visual. Additionally, the training tests contain item types that will not be used for students testing with the paper response option format during operational testing. These item types will not have paper response option cards or paper test visuals in this packet.

Paper Response Option Cards

ELA

build



ship



build



ship

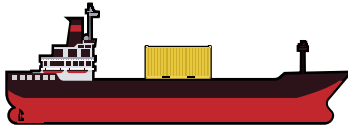

build



ship



ELA
Grade 11 Training
Test
Item 2

ELA
Grade 11 Training
Test
Item 2

ELA
Grade 11 Training
Test
Item 2

ELA
Grade 11 Training
Test
Item 2

ELA
Grade 11 Training
Test
Item 2

ELA
Grade 11 Training
Test
Item 2

safely



better

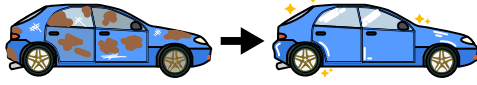

safely



better

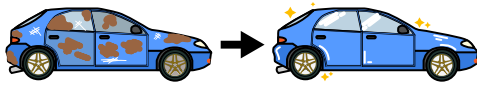

safely



better

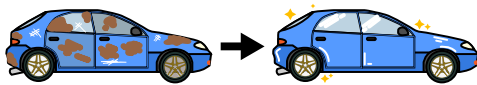

ELA
Grade 11 Training
Test
Item 3

ELA
Grade 11 Training
Test
Item 3

ELA
Grade 11 Training
Test
Item 3

ELA
Grade 11 Training
Test
Item 3

ELA
Grade 11 Training
Test
Item 3

ELA
Grade 11 Training
Test
Item 3

plant



trash bag

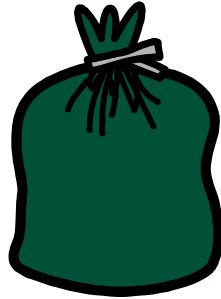

paint



plant



trash bag

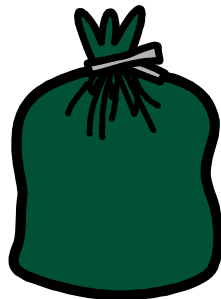

paint



plant



trash bag

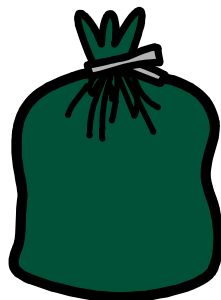

paint



ELA
Grade 11 Training
Test
Item 5

ELA
Grade 11 Training
Test
Item 5

ELA
Grade 11 Training
Test
Item 5

ELA
Grade 11 Training
Test
Item 5

ELA
Grade 11 Training
Test
Item 5

ELA
Grade 11 Training
Test
Item 5

ELA
Grade 11 Training
Test
Item 5

ELA
Grade 11 Training
Test
Item 5

ELA
Grade 11 Training
Test
Item 5

safe

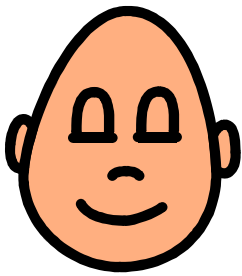

lost

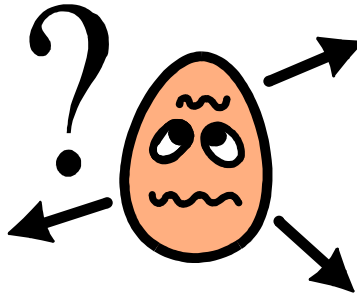

happy

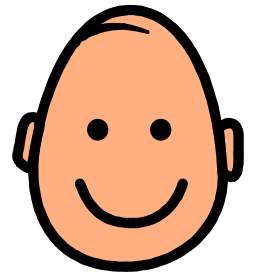

safe

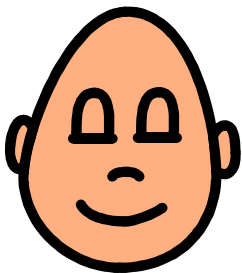

lost

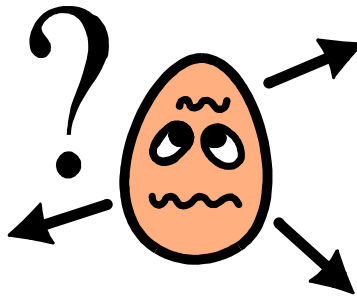

happy

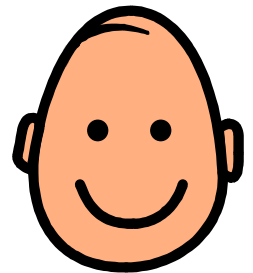

safe

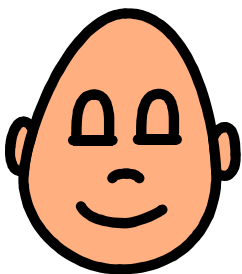

lost

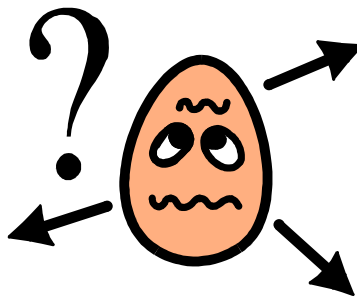

happy

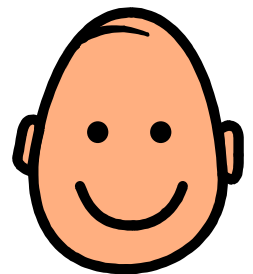

ELA
Grade 11 Training
Test
Item 6

ELA
Grade 11 Training
Test
Item 6

ELA
Grade 11 Training
Test
Item 6

ELA
Grade 11 Training
Test
Item 6

ELA
Grade 11 Training
Test
Item 6

ELA
Grade 11 Training
Test
Item 6

ELA
Grade 11 Training
Test
Item 6

ELA
Grade 11 Training
Test
Item 6

ELA
Grade 11 Training
Test
Item 6

mountains

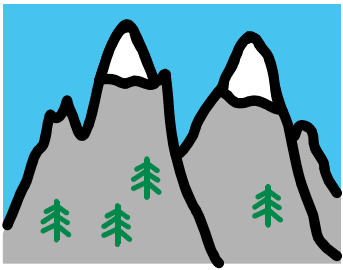

grocery
store

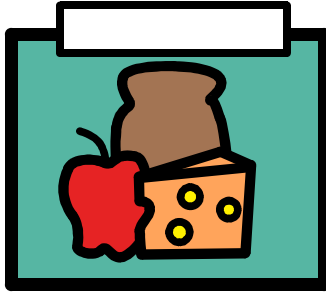

home



mountains

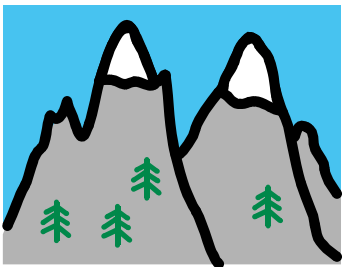

grocery
store

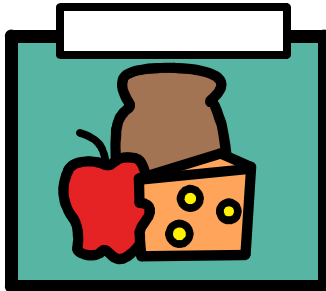

home



mountains

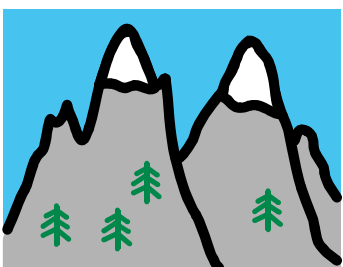

grocery
store

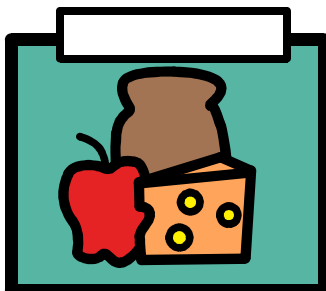

home



ELA
Grade 11 Training
Test
Item 7

ELA
Grade 11 Training
Test
Item 7

ELA
Grade 11 Training
Test
Item 7

ELA
Grade 11 Training
Test
Item 7

ELA
Grade 11 Training
Test
Item 7

ELA
Grade 11 Training
Test
Item 7

ELA
Grade 11 Training
Test
Item 7

ELA
Grade 11 Training
Test
Item 7

ELA
Grade 11 Training
Test
Item 7

woods

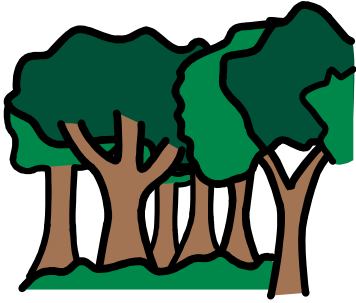

desert

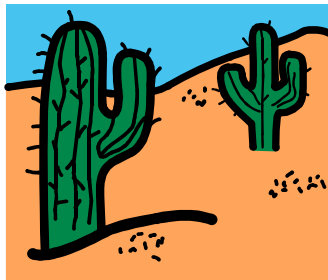

city



woods

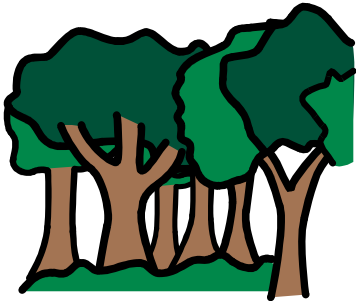

desert

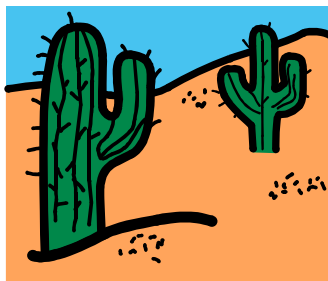

city



woods

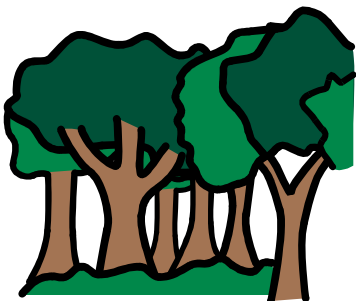

desert

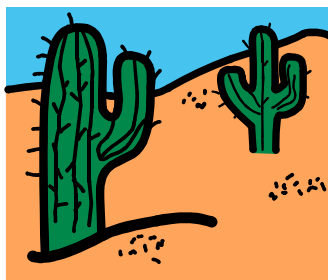

city



ELA
Grade 11 Training
Test
Item 8

ELA
Grade 11 Training
Test
Item 8

ELA
Grade 11 Training
Test
Item 8

ELA
Grade 11 Training
Test
Item 8

ELA
Grade 11 Training
Test
Item 8

ELA
Grade 11 Training
Test
Item 8

ELA
Grade 11 Training
Test
Item 8

ELA
Grade 11 Training
Test
Item 8

ELA
Grade 11 Training
Test
Item 8

**make
money**

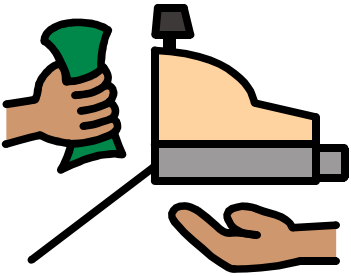

help

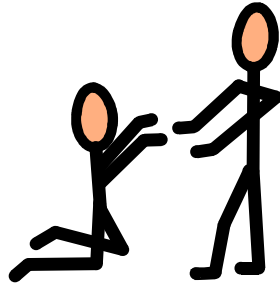

swim



**make
money**

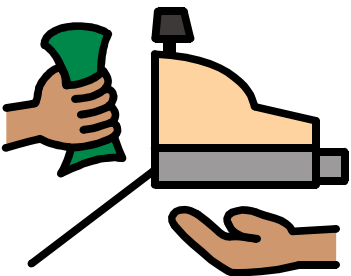

help

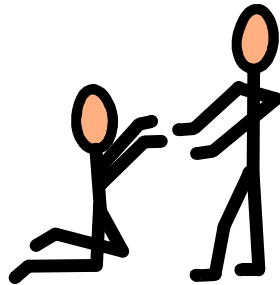

swim

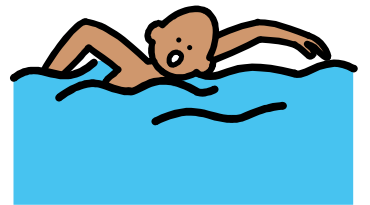

**make
money**

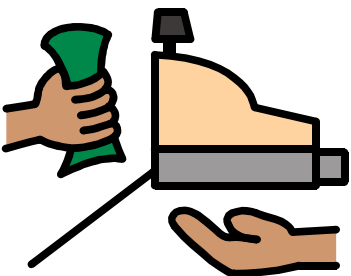

help

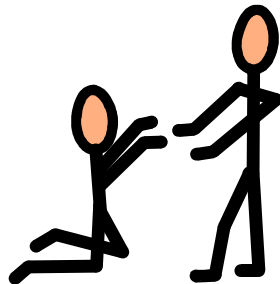

swim

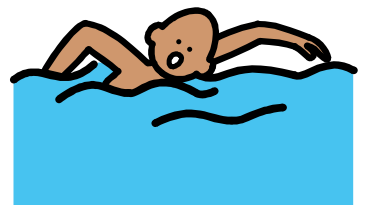

ELA
Grade 11 Training
Test
Item 9

ELA
Grade 11 Training
Test
Item 9

ELA
Grade 11 Training
Test
Item 9

ELA
Grade 11 Training
Test
Item 9

ELA
Grade 11 Training
Test
Item 9

ELA
Grade 11 Training
Test
Item 9

ELA
Grade 11 Training
Test
Item 9

ELA
Grade 11 Training
Test
Item 9

ELA
Grade 11 Training
Test
Item 9

baseball game



country



baseball game



country



baseball game



country



ELA
Grade 11 Training
Test
Item 11

ELA
Grade 11 Training
Test
Item 11

ELA
Grade 11 Training
Test
Item 11

ELA
Grade 11 Training
Test
Item 11

ELA
Grade 11 Training
Test
Item 11

ELA
Grade 11 Training
Test
Item 11

books



street

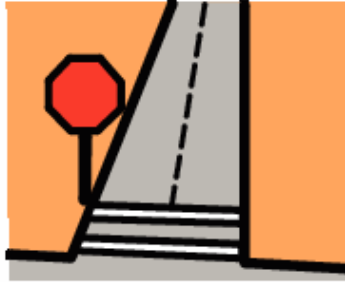

books



street



books



street



ELA
Grade 11 Training
Test
Item 12

ELA
Grade 11 Training
Test
Item 12

ELA
Grade 11 Training
Test
Item 12

ELA
Grade 11 Training
Test
Item 12

ELA
Grade 11 Training
Test
Item 12

ELA
Grade 11 Training
Test
Item 12

few



oven

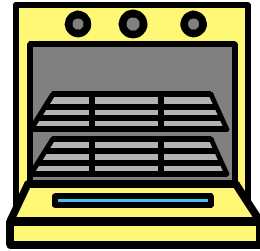

shapes

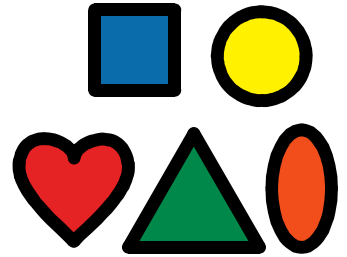

few



oven

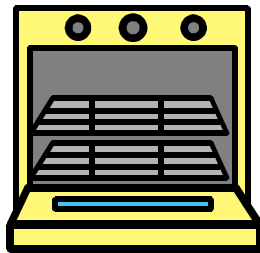

shapes

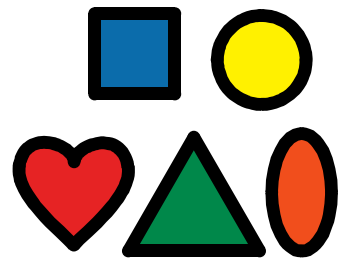

few



oven

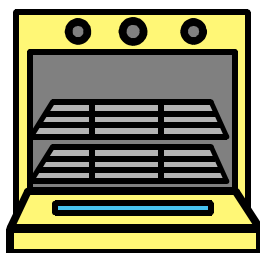

shapes

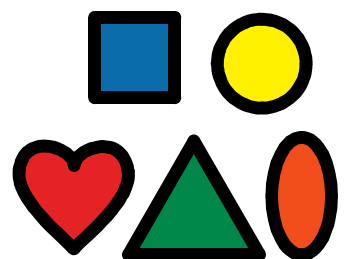

ELA
Grade 11 Training
Test
Item 19

ELA
Grade 11 Training
Test
Item 19

ELA
Grade 11 Training
Test
Item 19

ELA
Grade 11 Training
Test
Item 19

ELA
Grade 11 Training
Test
Item 19

ELA
Grade 11 Training
Test
Item 19

ELA
Grade 11 Training
Test
Item 19

ELA
Grade 11 Training
Test
Item 19

ELA
Grade 11 Training
Test
Item 19

stir

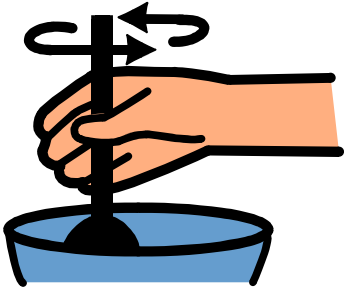

measure

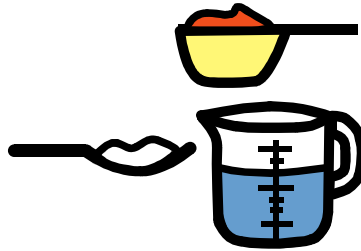

clean up



stir

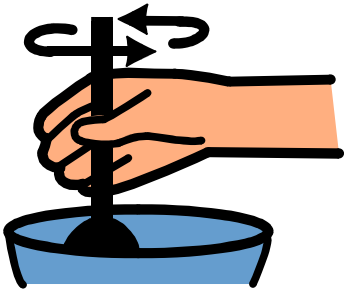

measure

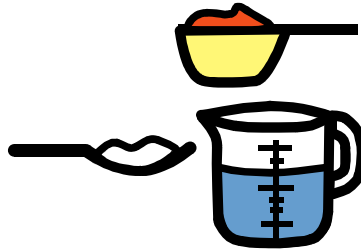

clean up



stir

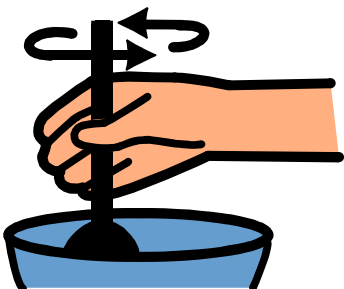

measure

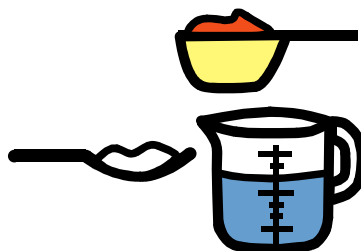

clean up



ELA
Grade 11 Training
Test
Item 20

ELA
Grade 11 Training
Test
Item 20

ELA
Grade 11 Training
Test
Item 20

ELA
Grade 11 Training
Test
Item 20

ELA
Grade 11 Training
Test
Item 20

ELA
Grade 11 Training
Test
Item 20

ELA
Grade 11 Training
Test
Item 20

ELA
Grade 11 Training
Test
Item 20

ELA
Grade 11 Training
Test
Item 20

shapes

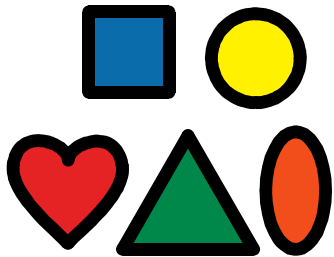

baking sheet

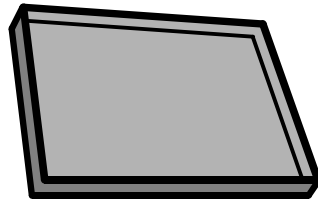

mix

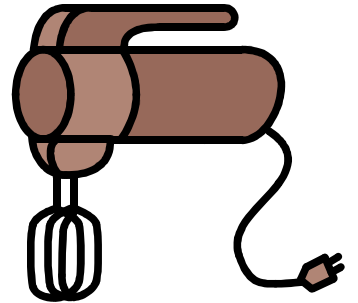

shapes

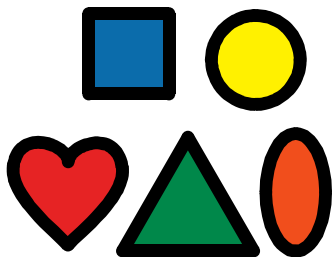

baking sheet

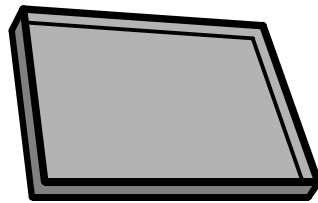

mix

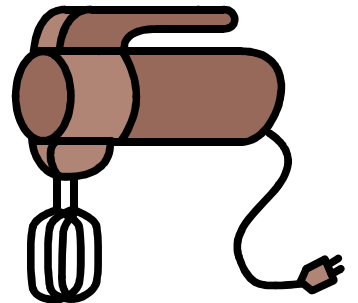

shapes

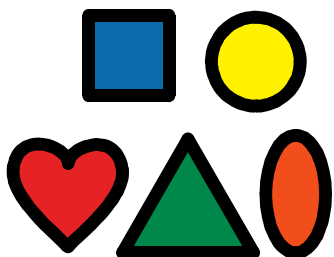

baking sheet

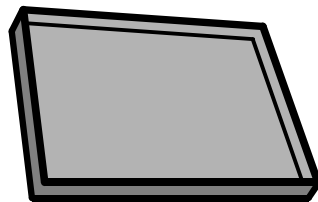

mix

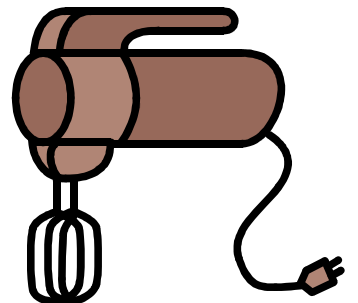

ELA
Grade 11 Training
Test
Item 21

ELA
Grade 11 Training
Test
Item 21

ELA
Grade 11 Training
Test
Item 21

ELA
Grade 11 Training
Test
Item 21

ELA
Grade 11 Training
Test
Item 21

ELA
Grade 11 Training
Test
Item 21

ELA
Grade 11 Training
Test
Item 21

ELA
Grade 11 Training
Test
Item 21

ELA
Grade 11 Training
Test
Item 21

together

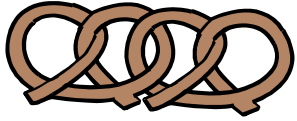

baking sheet

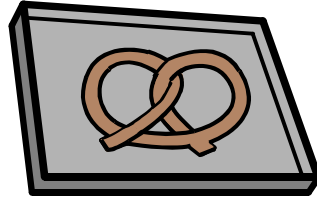

salt



together



baking sheet

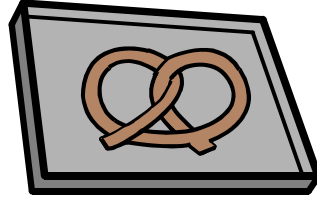

salt

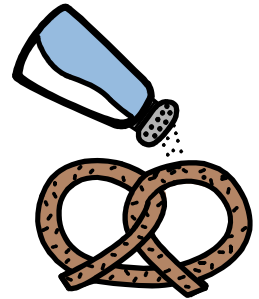

together

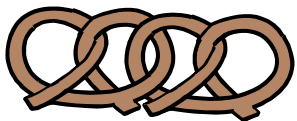

baking sheet

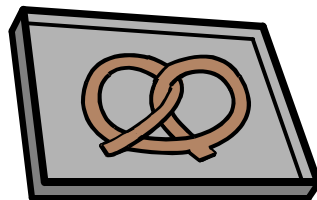

salt



ELA
Grade 11 Training
Test
Item 22

ELA
Grade 11 Training
Test
Item 22

ELA
Grade 11 Training
Test
Item 22

ELA
Grade 11 Training
Test
Item 22

ELA
Grade 11 Training
Test
Item 22

ELA
Grade 11 Training
Test
Item 22

ELA
Grade 11 Training
Test
Item 22

ELA
Grade 11 Training
Test
Item 22

ELA
Grade 11 Training
Test
Item 22

soft

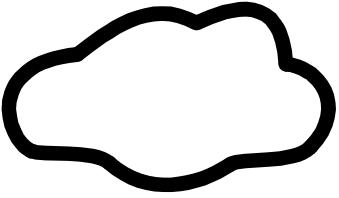

hot

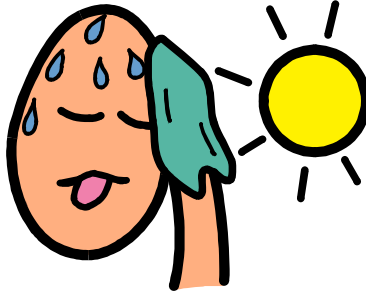

salt



soft

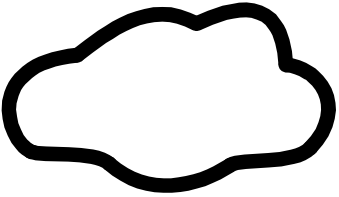

hot

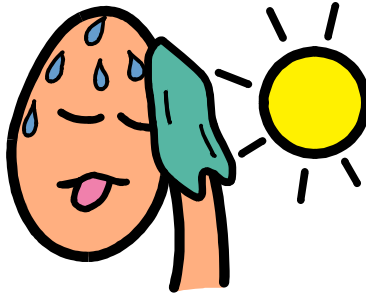

salt



soft

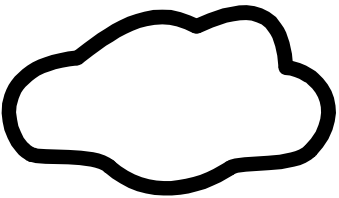

hot

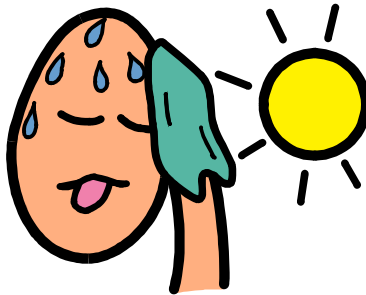

salt



ELA
Grade 11 Training
Test
Item 23

ELA
Grade 11 Training
Test
Item 23

ELA
Grade 11 Training
Test
Item 23

ELA
Grade 11 Training
Test
Item 23

ELA
Grade 11 Training
Test
Item 23

ELA
Grade 11 Training
Test
Item 23

ELA
Grade 11 Training
Test
Item 23

ELA
Grade 11 Training
Test
Item 23

ELA
Grade 11 Training
Test
Item 23

Paper Response Option Sentence Strips

ELA

She wants to work in a bookstore.



She wants to save money for a bike.



She likes making coffee for people.



ELA
Grade 11 Training Test
Item 1

ELA
Grade 11 Training Test
Item 1

ELA
Grade 11 Training Test
Item 1

to describe the history of New York
City



to tell a story about a trip on the
Hudson River



to provide information about the
Statue of Liberty



ELA
Grade 11 Training Test
Item 4

ELA
Grade 11 Training Test
Item 4

ELA
Grade 11 Training Test
Item 4

watery eyes



itchy skin



dry mouth



ELA
Grade 11 Training Test
Item 13

ELA
Grade 11 Training Test
Item 13

ELA
Grade 11 Training Test
Item 13

They can be harmful.



They can be friendly.



They can be noisy.



ELA
Grade 11 Training Test
Item 14

ELA
Grade 11 Training Test
Item 14

ELA
Grade 11 Training Test
Item 14

It makes insects bite.



It attracts many insects.



It keeps insects away.



ELA
Grade 11 Training Test
Item 15

ELA
Grade 11 Training Test
Item 15

ELA
Grade 11 Training Test
Item 15

During this time



Since then



When he began



Because of this

ELA
Grade 11 Training Test
Item 16

ELA
Grade 11 Training Test
Item 16

ELA
Grade 11 Training Test
Item 16

ELA
Grade 11 Training Test
Item 16

Spend ten bucks if you want to see
Lincoln.



Lincoln, however, can be spent on
five bucks.



However, Lincoln's picture is also
on the five-dollar bill.



ELA
Grade 11 Training Test
Item 17

ELA
Grade 11 Training Test
Item 17

ELA
Grade 11 Training Test
Item 17

a shopping catalog



television commercials



the U.S. Treasury website



ELA
Grade 11 Training Test
Item 18

ELA
Grade 11 Training Test
Item 18

ELA
Grade 11 Training Test
Item 18

Paper Response Option Cards

Mathematics

1



2



4



1



2



4



1



2



4



MATH
Grade 11 Training
Test
Item 1

MATH
Grade 11 Training
Test
Item 1

MATH
Grade 11 Training
Test
Item 1

MATH
Grade 11 Training
Test
Item 1

MATH
Grade 11 Training
Test
Item 1

MATH
Grade 11 Training
Test
Item 1

MATH
Grade 11 Training
Test
Item 1

MATH
Grade 11 Training
Test
Item 1

MATH
Grade 11 Training
Test
Item 1

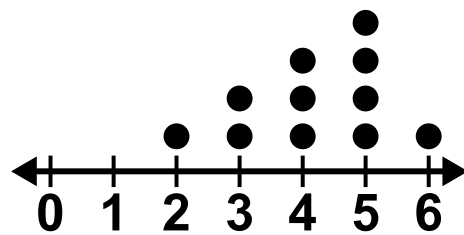
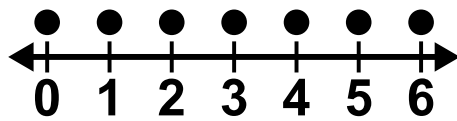
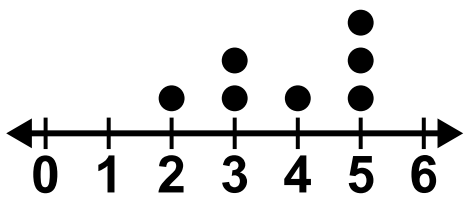
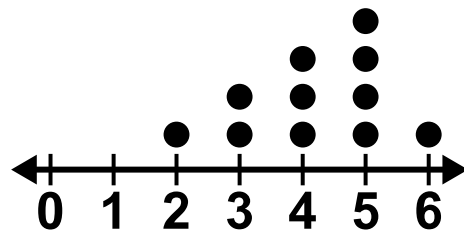
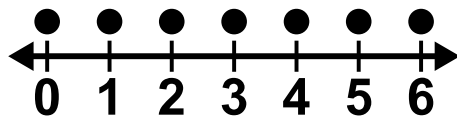
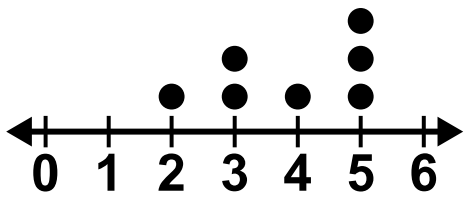
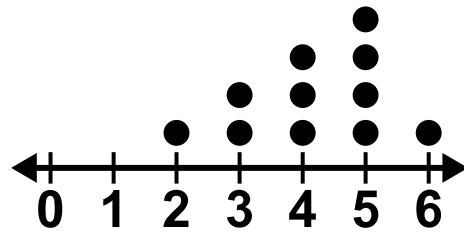
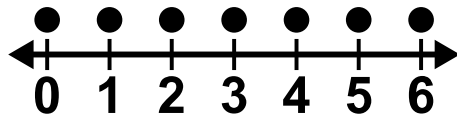
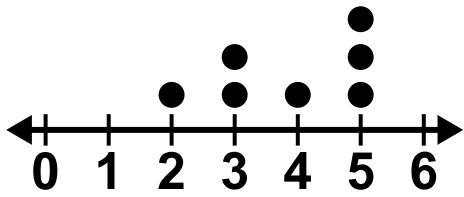

MATH
Grade 11 Training
Test
Item 4

MATH
Grade 11 Training
Test
Item 4

MATH
Grade 11 Training
Test
Item 4

MATH
Grade 11 Training
Test
Item 4

MATH
Grade 11 Training
Test
Item 4

MATH
Grade 11 Training
Test
Item 4

MATH
Grade 11 Training
Test
Item 4

MATH
Grade 11 Training
Test
Item 4

MATH
Grade 11 Training
Test
Item 4

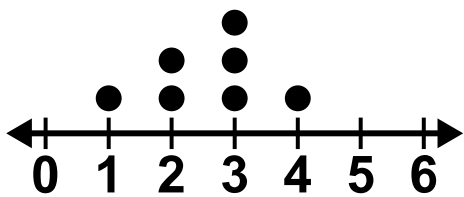
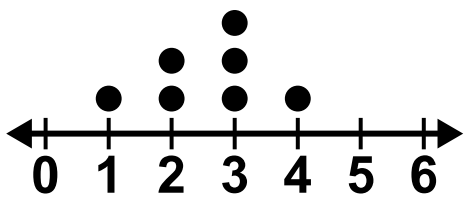
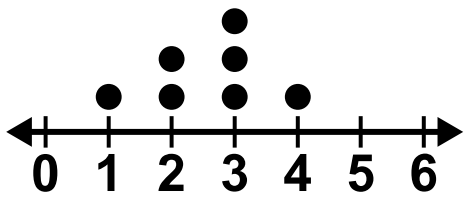

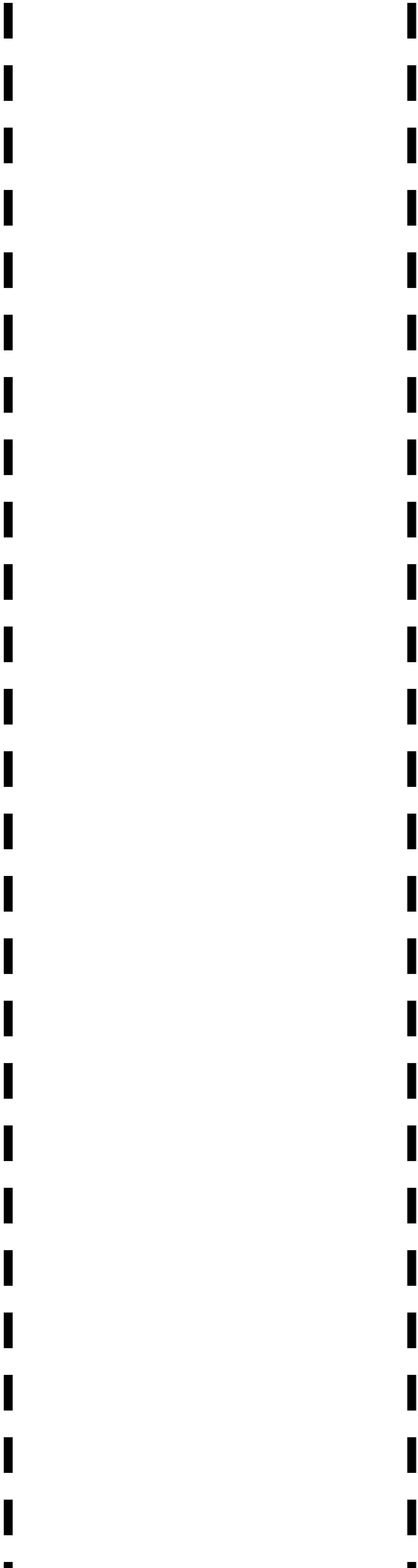

MATH
Grade 11 Training
Test
Item 4

MATH
Grade 11 Training
Test
Item 4

MATH
Grade 11 Training
Test
Item 4

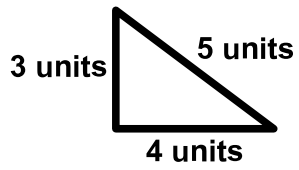
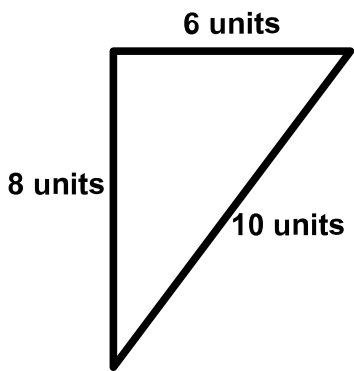
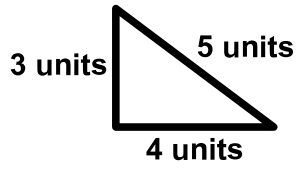
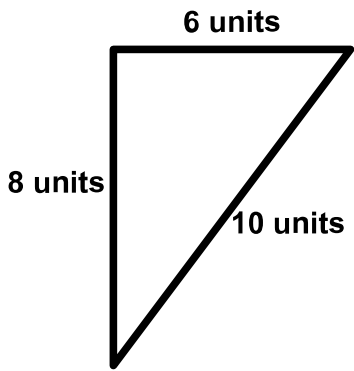
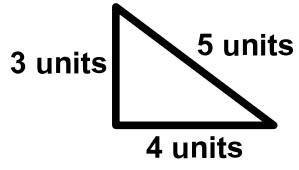
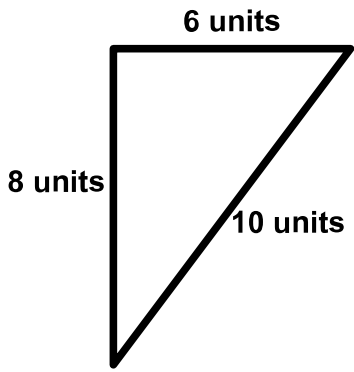

MATH
Grade 11 Training
Test
Item 5

MATH
Grade 11 Training
Test
Item 5

MATH
Grade 11 Training
Test
Item 5

MATH
Grade 11 Training
Test
Item 5

MATH
Grade 11 Training
Test
Item 5

MATH
Grade 11 Training
Test
Item 5

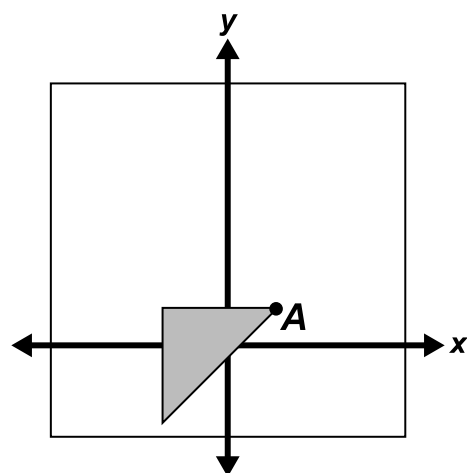
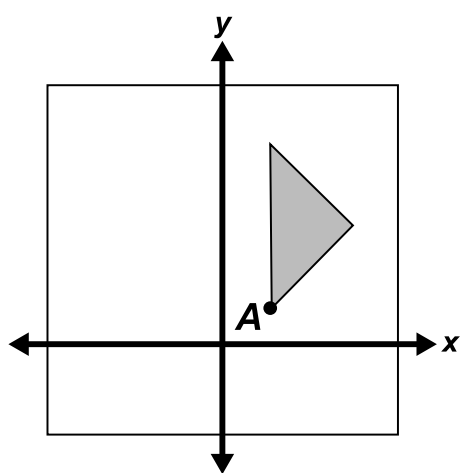
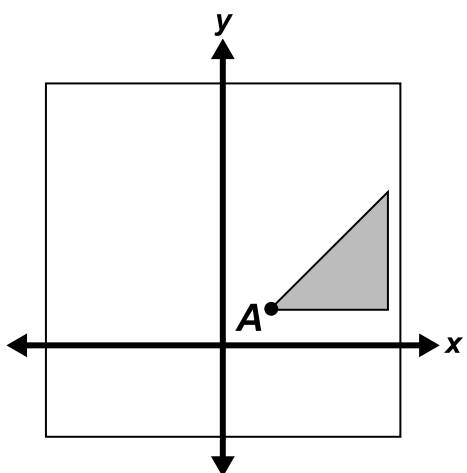
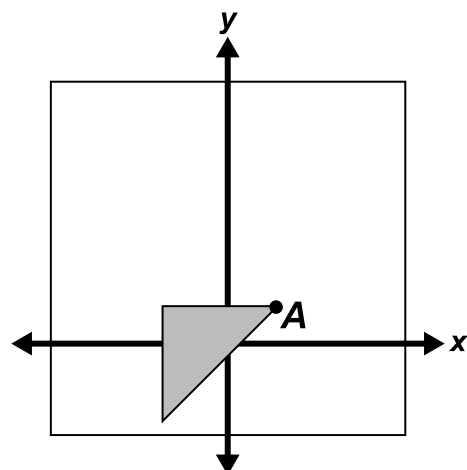
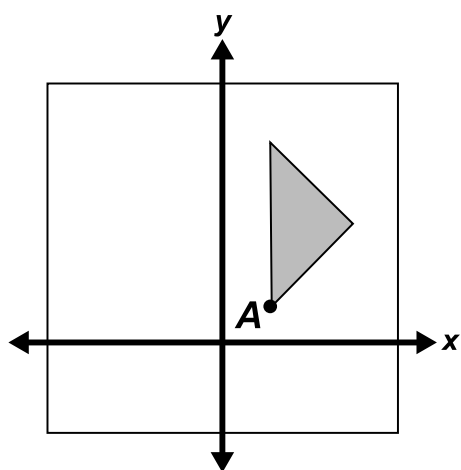
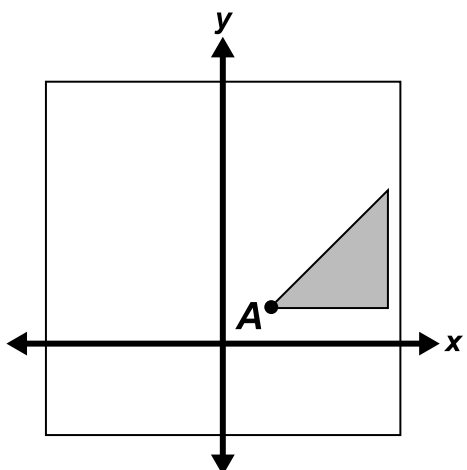
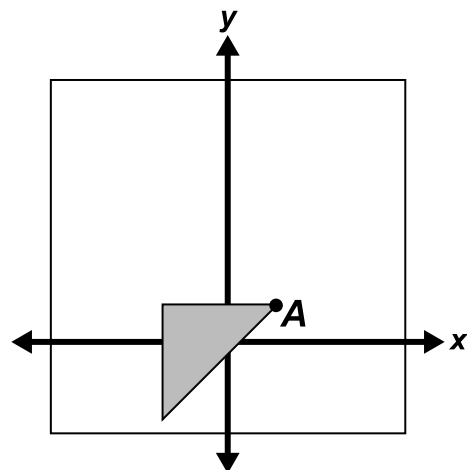
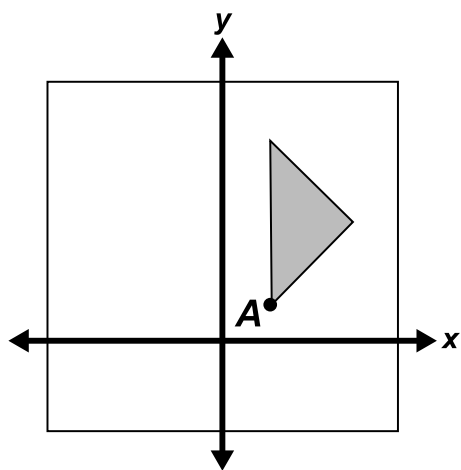
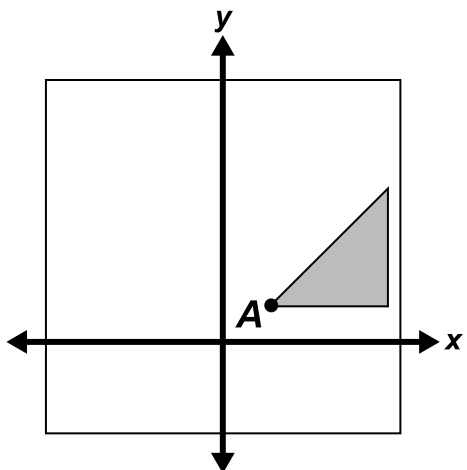

MATH
Grade 11 Training
Test
Item 7

MATH
Grade 11 Training
Test
Item 7

MATH
Grade 11 Training
Test
Item 7

MATH
Grade 11 Training
Test
Item 7

MATH
Grade 11 Training
Test
Item 7

MATH
Grade 11 Training
Test
Item 7

MATH
Grade 11 Training
Test
Item 7

MATH
Grade 11 Training
Test
Item 7

MATH
Grade 11 Training
Test
Item 7

2

2

2

22

22

22

100

100

100

MATH
Grade 11 Training
Test
Item 8

MATH
Grade 11 Training
Test
Item 8

MATH
Grade 11 Training
Test
Item 8

MATH
Grade 11 Training
Test
Item 8

MATH
Grade 11 Training
Test
Item 8

MATH
Grade 11 Training
Test
Item 8

MATH
Grade 11 Training
Test
Item 8

MATH
Grade 11 Training
Test
Item 8

MATH
Grade 11 Training
Test
Item 8

120

120

120

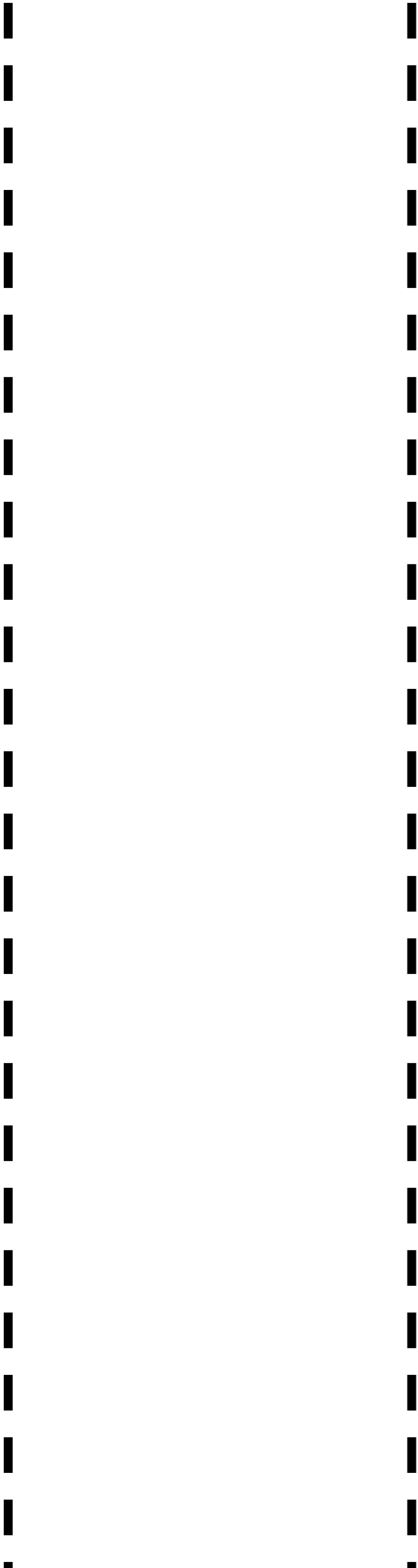

MATH
Grade 11 Training
Test
Item 8

MATH
Grade 11 Training
Test
Item 8

MATH
Grade 11 Training
Test
Item 8

$$n^2$$

$$n^3$$

$$n^4$$

$$n^2$$

$$n^3$$

$$n^4$$

$$n^2$$

$$n^3$$

$$n^4$$

MATH
Grade 11 Training
Test
Item 9

MATH
Grade 11 Training
Test
Item 9

MATH
Grade 11 Training
Test
Item 9

MATH
Grade 11 Training
Test
Item 9

MATH
Grade 11 Training
Test
Item 9

MATH
Grade 11 Training
Test
Item 9

MATH
Grade 11 Training
Test
Item 9

MATH
Grade 11 Training
Test
Item 9

MATH
Grade 11 Training
Test
Item 9

$$n^5$$

$$n^4$$

$$n^3$$

$$n^5$$

$$n^4$$

$$n^3$$

$$n^5$$

$$n^4$$

$$n^3$$

MATH
Grade 11 Training
Test
Item 10

MATH
Grade 11 Training
Test
Item 10

MATH
Grade 11 Training
Test
Item 10

MATH
Grade 11 Training
Test
Item 10

MATH
Grade 11 Training
Test
Item 10

MATH
Grade 11 Training
Test
Item 10

MATH
Grade 11 Training
Test
Item 10

MATH
Grade 11 Training
Test
Item 10

MATH
Grade 11 Training
Test
Item 10

$4 + a \mid 4 \times a \mid 4 - a$

$4 + a \mid 4 \times a \mid 4 - a$

$4 + a \mid 4 \times a \mid 4 - a$

MATH
Grade 11 Training
Test
Item 11

MATH
Grade 11 Training
Test
Item 11

MATH
Grade 11 Training
Test
Item 11

MATH
Grade 11 Training
Test
Item 11

MATH
Grade 11 Training
Test
Item 11

MATH
Grade 11 Training
Test
Item 11

MATH
Grade 11 Training
Test
Item 11

MATH
Grade 11 Training
Test
Item 11

MATH
Grade 11 Training
Test
Item 11

Point A

Point B

Point A

Point B

Point A

Point B

MATH
Grade 11 Training
Test
Item 12

MATH
Grade 11 Training
Test
Item 12

MATH
Grade 11 Training
Test
Item 12

MATH
Grade 11 Training
Test
Item 12

MATH
Grade 11 Training
Test
Item 12

MATH
Grade 11 Training
Test
Item 12

x^2y

x^2y^2

xy^2

x^2y

x^2y^2

xy^2

x^2y

x^2y^2

xy^2

MATH
Grade 11 Training
Test
Item 15

MATH
Grade 11 Training
Test
Item 15

MATH
Grade 11 Training
Test
Item 15

MATH
Grade 11 Training
Test
Item 15

MATH
Grade 11 Training
Test
Item 15

MATH
Grade 11 Training
Test
Item 15

MATH
Grade 11 Training
Test
Item 15

MATH
Grade 11 Training
Test
Item 15

MATH
Grade 11 Training
Test
Item 15

x^2y^2

x^2y

xy^2

x^2y^2

x^2y

xy^2

x^2y^2

x^2y

xy^2

MATH
Grade 11 Training
Test
Item 16

MATH
Grade 11 Training
Test
Item 16

MATH
Grade 11 Training
Test
Item 16

MATH
Grade 11 Training
Test
Item 16

MATH
Grade 11 Training
Test
Item 16

MATH
Grade 11 Training
Test
Item 16

MATH
Grade 11 Training
Test
Item 16

MATH
Grade 11 Training
Test
Item 16

MATH
Grade 11 Training
Test
Item 16

$(0, 2)$

$(2, 0)$

$(0, 0)$

$(0, 2)$

$(2, 0)$

$(0, 0)$

$(0, 2)$

$(2, 0)$

$(0, 0)$

MATH
Grade 11 Training
Test
Item 17

MATH
Grade 11 Training
Test
Item 17

MATH
Grade 11 Training
Test
Item 17

MATH
Grade 11 Training
Test
Item 17

MATH
Grade 11 Training
Test
Item 17

MATH
Grade 11 Training
Test
Item 17

MATH
Grade 11 Training
Test
Item 17

MATH
Grade 11 Training
Test
Item 17

MATH
Grade 11 Training
Test
Item 17

5|2|5|2|5|2

4|2|4|2|4|2

5|3|5|3|5|3

MATH
Grade 11 Training
Test
Item 18

MATH
Grade 11 Training
Test
Item 18

MATH
Grade 11 Training
Test
Item 18

MATH
Grade 11 Training
Test
Item 18

MATH
Grade 11 Training
Test
Item 18

MATH
Grade 11 Training
Test
Item 18

MATH
Grade 11 Training
Test
Item 18

MATH
Grade 11 Training
Test
Item 18

MATH
Grade 11 Training
Test
Item 18

$$2x + 4 \quad 8x + 4 \quad 8x + 8$$

$$2x + 4 \quad 8x + 4 \quad 8x + 8$$

$$2x + 4 \quad 8x + 4 \quad 8x + 8$$

MATH
Grade 11 Training
Test
Item 19

MATH
Grade 11 Training
Test
Item 19

MATH
Grade 11 Training
Test
Item 19

MATH
Grade 11 Training
Test
Item 19

MATH
Grade 11 Training
Test
Item 19

MATH
Grade 11 Training
Test
Item 19

MATH
Grade 11 Training
Test
Item 19

MATH
Grade 11 Training
Test
Item 19

MATH
Grade 11 Training
Test
Item 19

$12x$

$12x$

$12x$

MATH
Grade 11 Training
Test
Item 19

MATH
Grade 11 Training
Test
Item 19

MATH
Grade 11 Training
Test
Item 19

$$r = \frac{s}{2} \quad | \quad r = 2s \quad | \quad r = s - 2$$

$$r = \frac{s}{2} \quad | \quad r = 2s \quad | \quad r = s - 2$$

$$r = \frac{s}{2} \quad | \quad r = 2s \quad | \quad r = s - 2$$

MATH
Grade 11 Training
Test
Item 20

MATH
Grade 11 Training
Test
Item 20

MATH
Grade 11 Training
Test
Item 20

MATH
Grade 11 Training
Test
Item 20

MATH
Grade 11 Training
Test
Item 20

MATH
Grade 11 Training
Test
Item 20

MATH
Grade 11 Training
Test
Item 20

MATH
Grade 11 Training
Test
Item 20

MATH
Grade 11 Training
Test
Item 20

$$r = s + 2$$

$$r = s + 2$$

$$r = s + 2$$

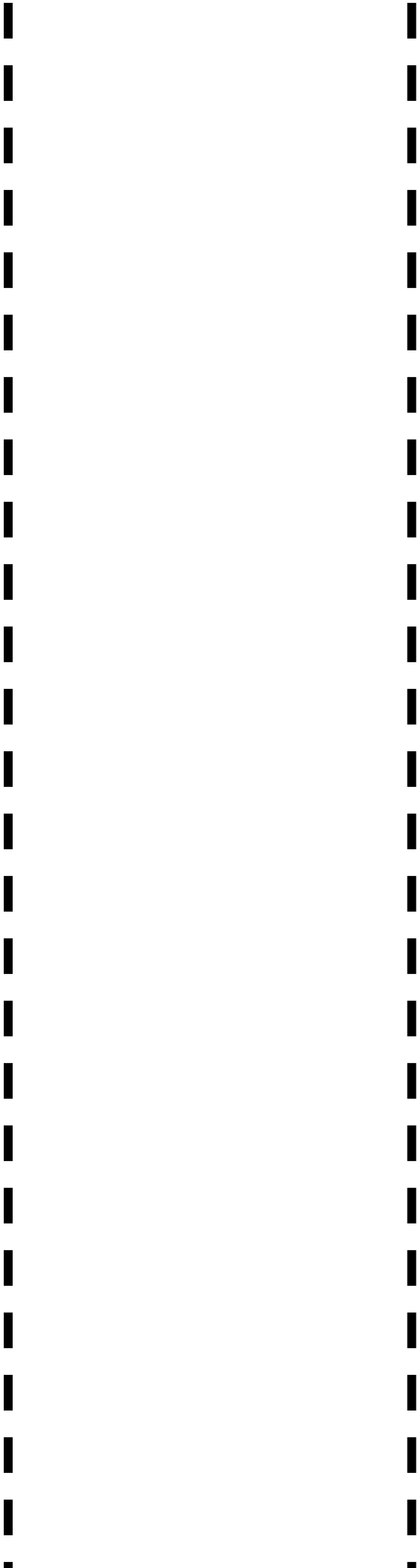

MATH
Grade 11 Training
Test
Item 20

MATH
Grade 11 Training
Test
Item 20

MATH
Grade 11 Training
Test
Item 20

**Paper Response
Option Sentence Strips**

Mathematics

diameter



radius



MATH
Grade 11 Training Test
Item 2

MATH
Grade 11 Training Test
Item 2

12 cubic inches



16 cubic inches



64 cubic inches



MATH
Grade 11 Training Test
Item 3

MATH
Grade 11 Training Test
Item 3

MATH
Grade 11 Training Test
Item 3

24 square units



48 square units



60 square units



MATH
Grade 11 Training Test
Item 13

MATH
Grade 11 Training Test
Item 13

MATH
Grade 11 Training Test
Item 13

add 4 and 9



multiply 4 by 9



subtract 4 from 9



MATH
Grade 11 Training Test
Item 14

MATH
Grade 11 Training Test
Item 14

MATH
Grade 11 Training Test
Item 14

1, 2, 3, 4



5, 8, 11, 14



MATH
Grade 11 Training Test
Item 21

MATH
Grade 11 Training Test
Item 21

Paper Test Visuals

Mathematics

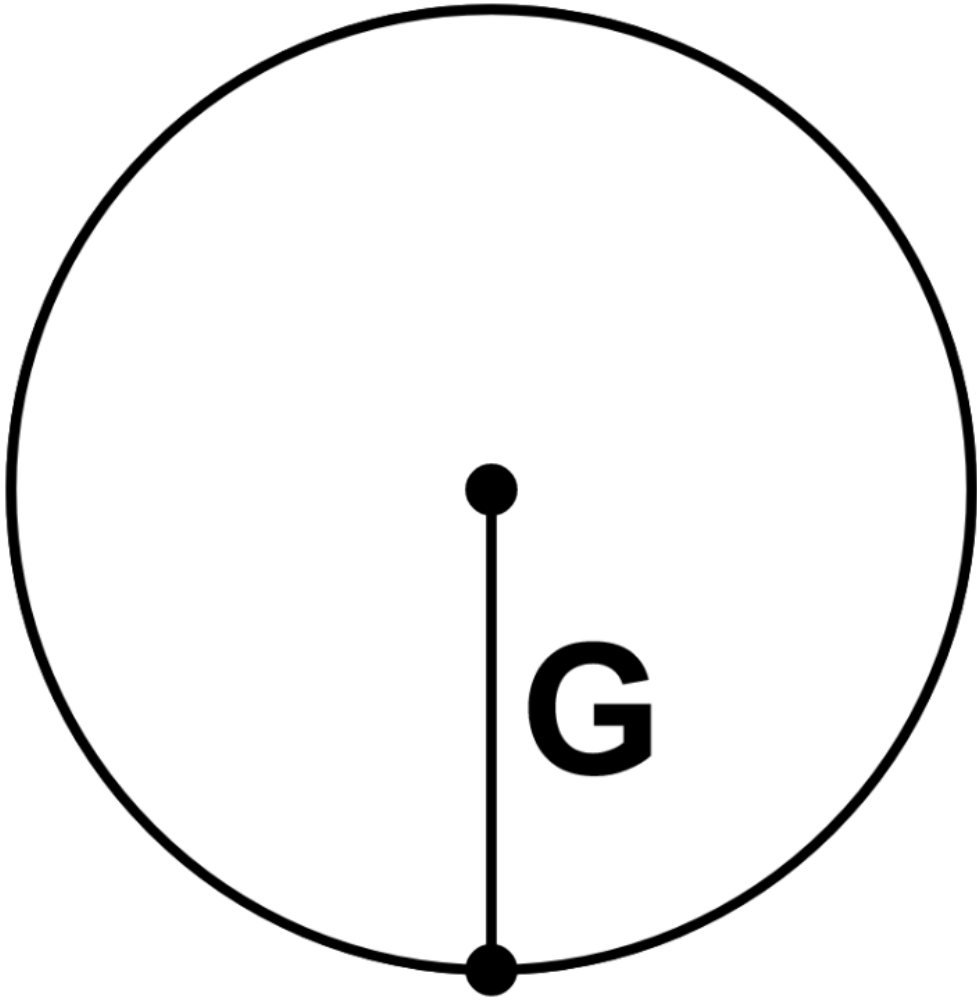

HSA-Alt Training
Test Math Grade 11
Item #2

$n \cdot n \cdot n$

HSA-Alt Training
Test Math Grade 11
Item #9

n • n • n • n • n

HSA-Alt Training
Test Math Grade 11
Item #10

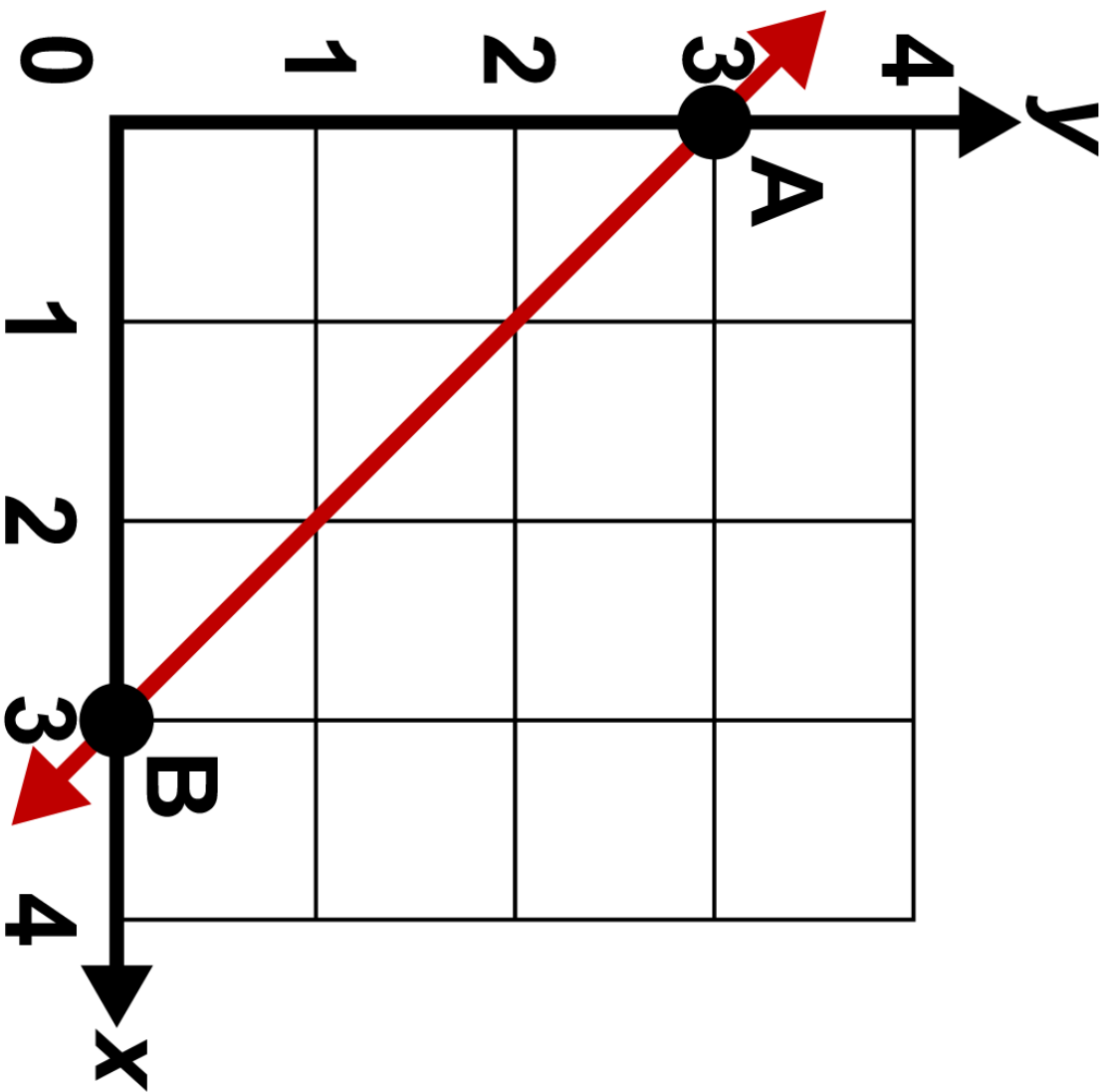

HSA-Alt Training
Test Math Grade 11
Item #12

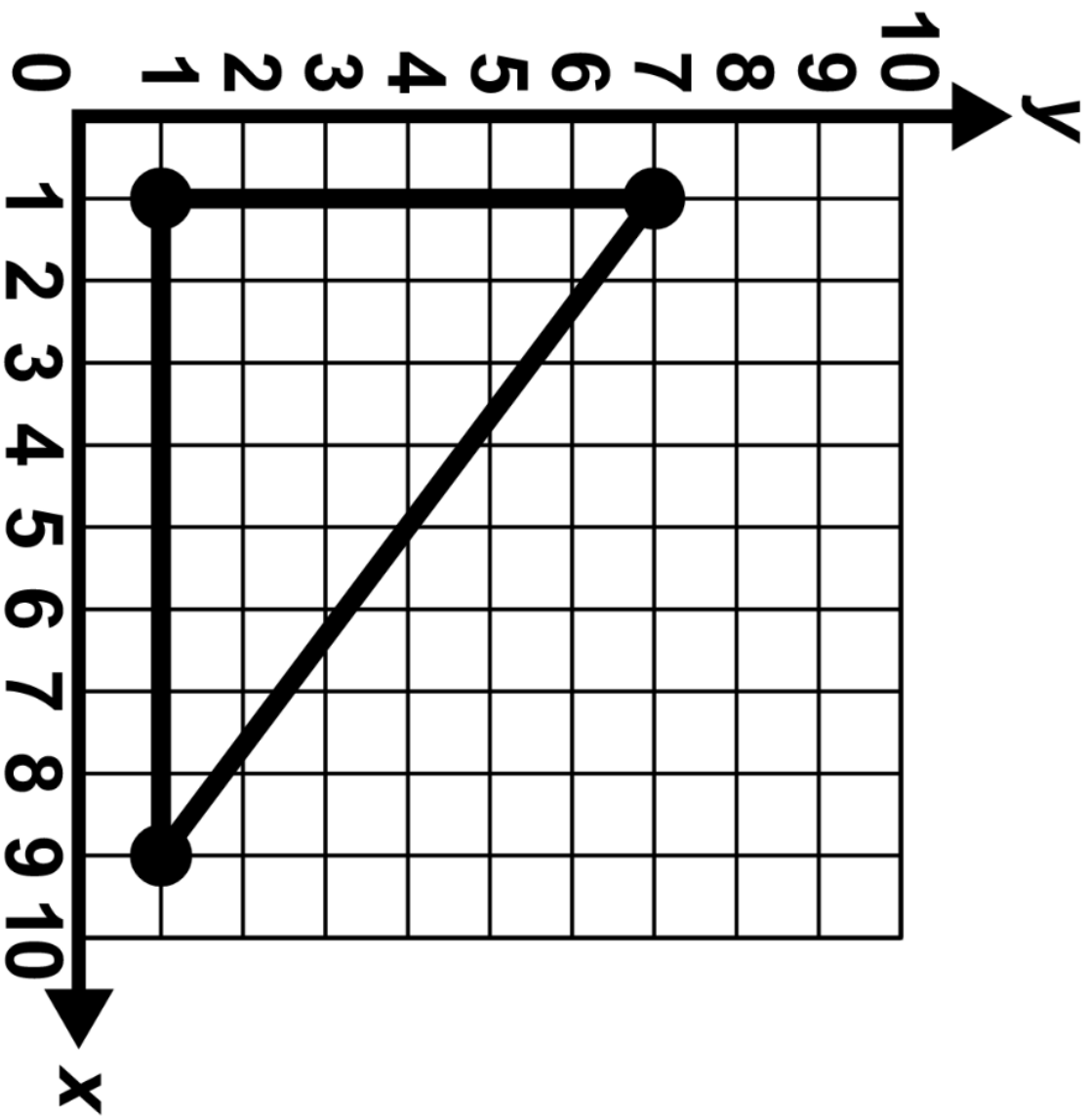

HSA-Alt Training
Test Math Grade 11
Item #13

$\gamma \cdot X \cdot X$

HSA-Alt Training Test
Math Grade 11
Item #15

$f \cdot y \cdot X$

HSA-Alt Training
Test Math Grade 11
Item #16

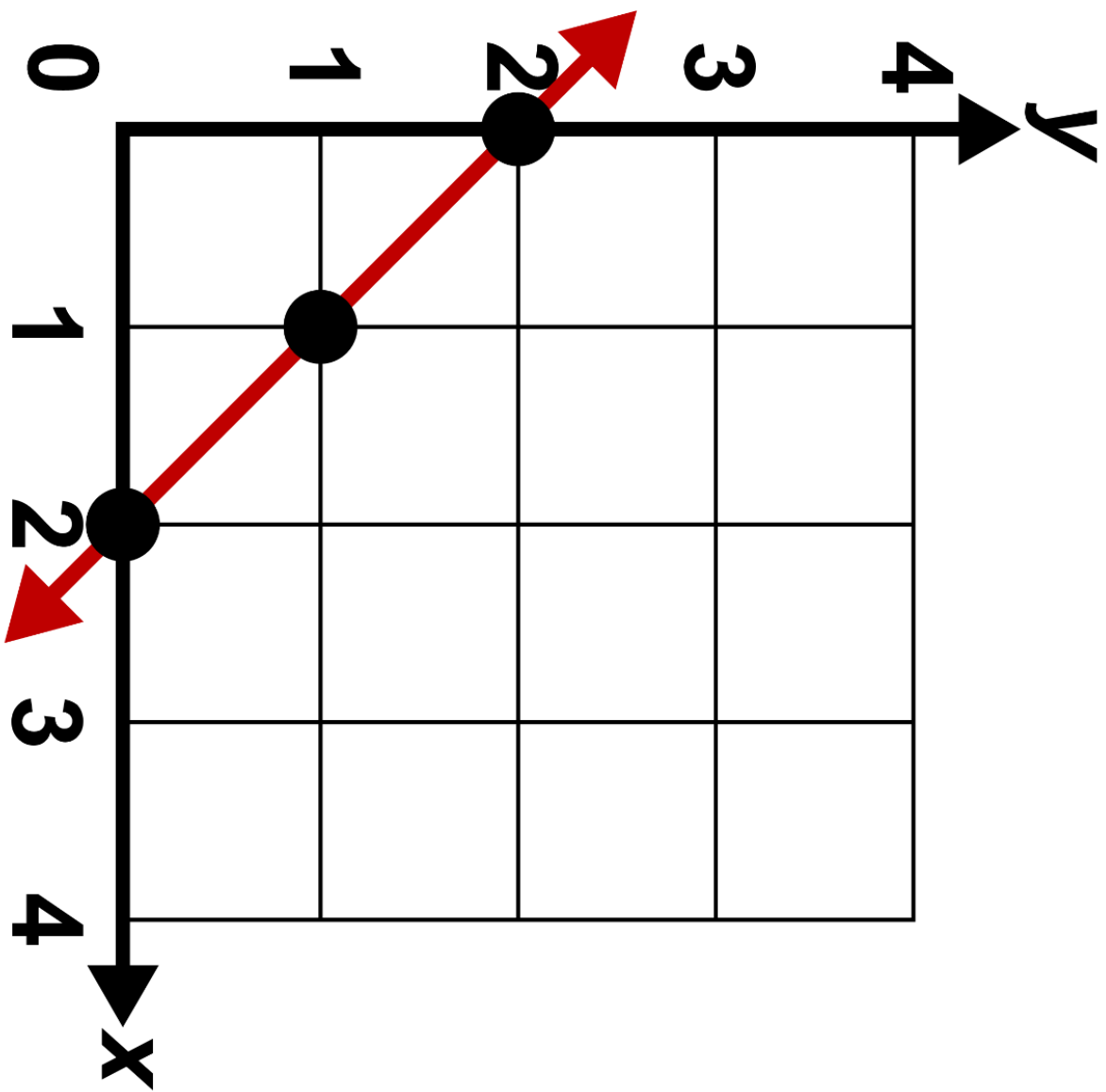

HSA-Alt Training
Test Math Grade 11
Item #17

x	$f(x)$
1	5
2	8
3	11
4	14

HSA-Alt Training
Test Math Grade 11
Item #21

Paper Response Option Cards

Science

genes



organelles

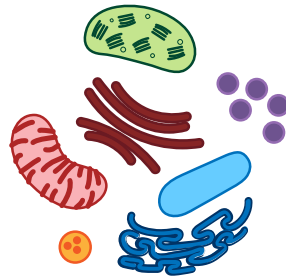

genes



organelles

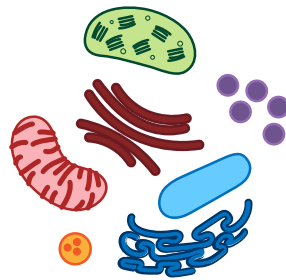

genes



organelles

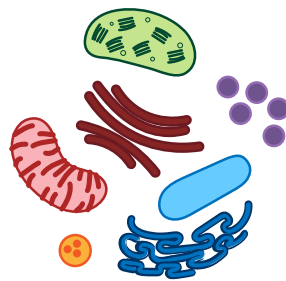

SCIENCE
Grade 11 Training
Test
Item 1

SCIENCE
Grade 11 Training
Test
Item 1

SCIENCE
Grade 11 Training
Test
Item 1

SCIENCE
Grade 11 Training
Test
Item 1

SCIENCE
Grade 11 Training
Test
Item 1

SCIENCE
Grade 11 Training
Test
Item 1

sweat

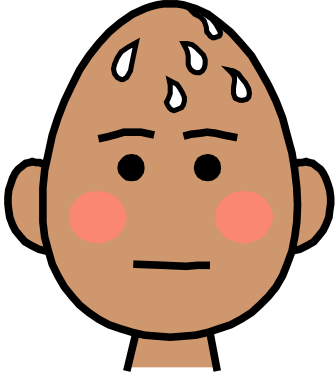

sneeze



sleep



sweat

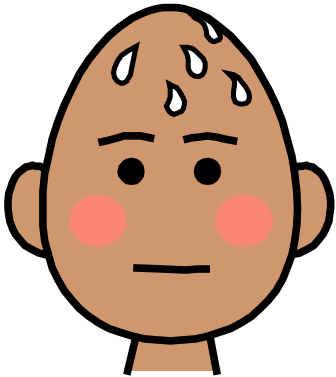

sneeze



sleep

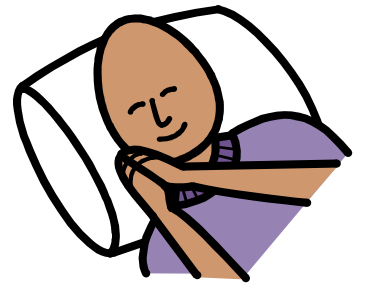

sweat

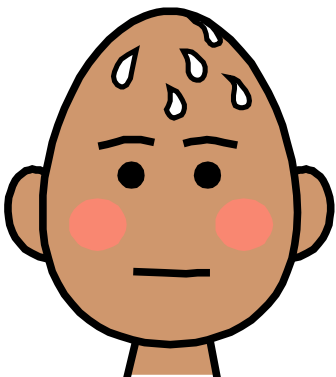

sneeze



sleep

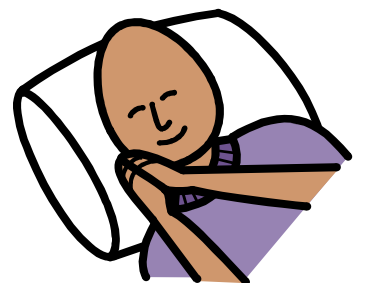

SCIENCE
Grade 11 Training
Test
Item 3

SCIENCE
Grade 11 Training
Test
Item 3

SCIENCE
Grade 11 Training
Test
Item 3

SCIENCE
Grade 11 Training
Test
Item 3

SCIENCE
Grade 11 Training
Test
Item 3

SCIENCE
Grade 11 Training
Test
Item 3

SCIENCE
Grade 11 Training
Test
Item 3

SCIENCE
Grade 11 Training
Test
Item 3

SCIENCE
Grade 11 Training
Test
Item 3

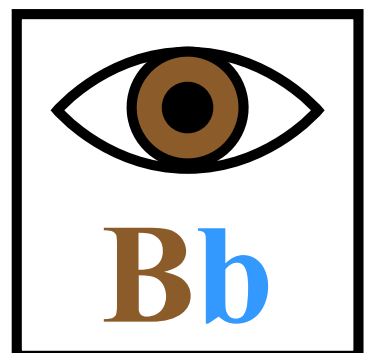
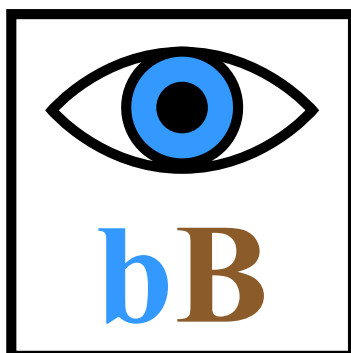
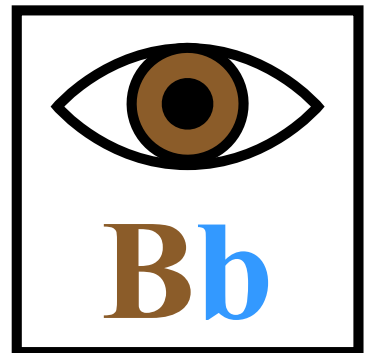
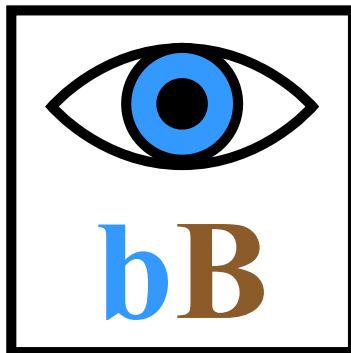
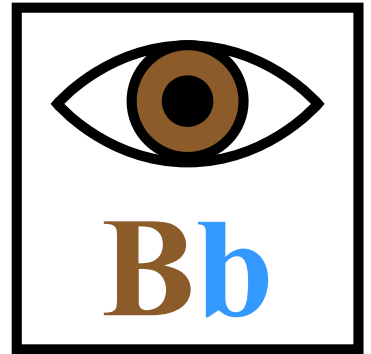
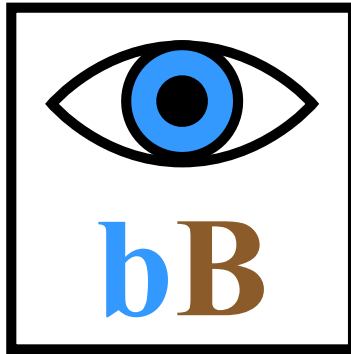

SCIENCE
Grade 11 Training
Test
Item 4

SCIENCE
Grade 11 Training
Test
Item 4

SCIENCE
Grade 11 Training
Test
Item 4

SCIENCE
Grade 11 Training
Test
Item 4

SCIENCE
Grade 11 Training
Test
Item 4

SCIENCE
Grade 11 Training
Test
Item 4

SCIENCE
Grade 11 Training
Test
Item 4

SCIENCE
Grade 11 Training
Test
Item 4

SCIENCE
Grade 11 Training
Test
Item 4



SCIENCE
Grade 11 Training
Test
Item 4

SCIENCE
Grade 11 Training
Test
Item 4

SCIENCE
Grade 11 Training
Test
Item 4

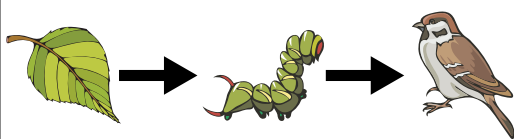
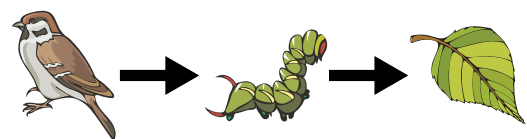
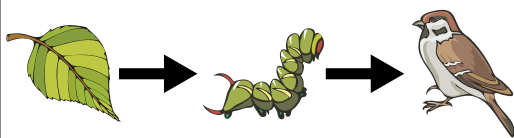
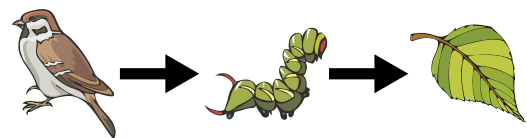
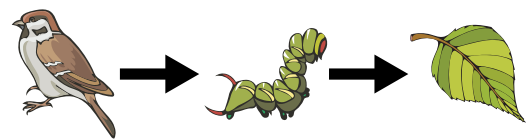

SCIENCE
Grade 11 Training
Test
Item 7

SCIENCE
Grade 11 Training
Test
Item 7

SCIENCE
Grade 11 Training
Test
Item 7

SCIENCE
Grade 11 Training
Test
Item 7

SCIENCE
Grade 11 Training
Test
Item 7

SCIENCE
Grade 11 Training
Test
Item 7

SCIENCE
Grade 11 Training
Test
Item 7

SCIENCE
Grade 11 Training
Test
Item 7

SCIENCE
Grade 11 Training
Test
Item 7

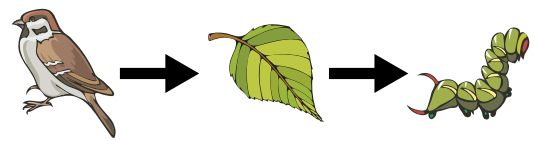
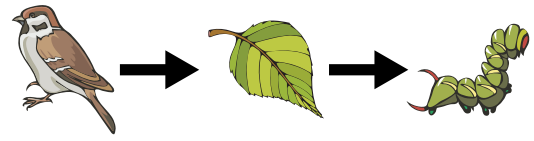
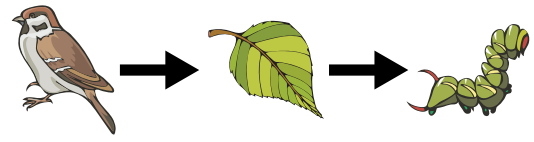

SCIENCE
Grade 11 Training
Test
Item 7

SCIENCE
Grade 11 Training
Test
Item 7

SCIENCE
Grade 11 Training
Test
Item 7

Inputs
soil + water + oxygen

↓

Outputs
carbon dioxide
+ glucose

Inputs
fertilizer + sunlight
+ glucose

↓

Outputs
water + oxygen

Inputs
sunlight + water
+ carbon dioxide

↓

Outputs
glucose + oxygen

Inputs
soil + water + oxygen

↓

Outputs
carbon dioxide
+ glucose

Inputs
fertilizer + sunlight
+ glucose

↓

Outputs
water + oxygen

Inputs
sunlight + water
+ carbon dioxide

↓

Outputs
glucose + oxygen

Inputs
soil + water + oxygen

↓

Outputs
carbon dioxide
+ glucose

Inputs
fertilizer + sunlight
+ glucose

↓

Outputs
water + oxygen

Inputs
sunlight + water
+ carbon dioxide

↓

Outputs
glucose + oxygen

SCIENCE
Grade 11 Training
Test
Item 9

SCIENCE
Grade 11 Training
Test
Item 9

SCIENCE
Grade 11 Training
Test
Item 9

SCIENCE
Grade 11 Training
Test
Item 9

SCIENCE
Grade 11 Training
Test
Item 9

SCIENCE
Grade 11 Training
Test
Item 9

SCIENCE
Grade 11 Training
Test
Item 9

SCIENCE
Grade 11 Training
Test
Item 9

SCIENCE
Grade 11 Training
Test
Item 9

extinction

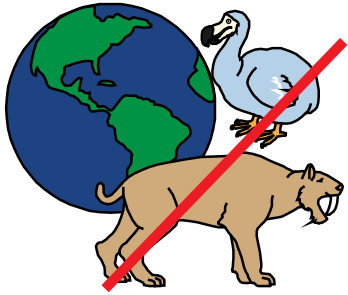

pollution

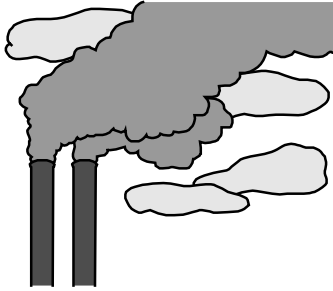

evolution

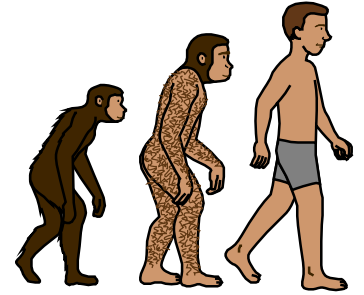

extinction

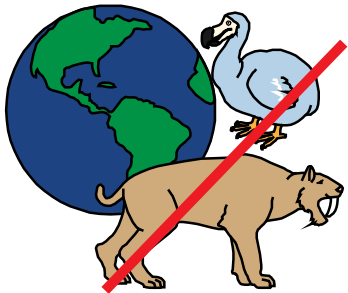

pollution

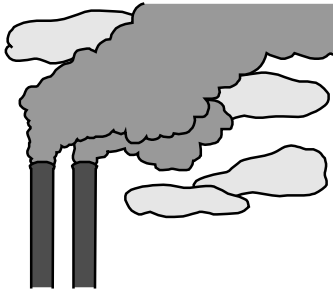

evolution

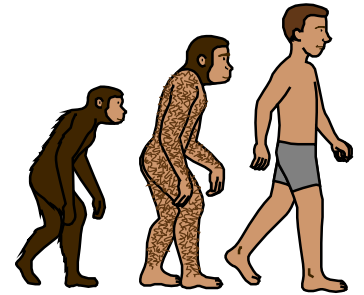

extinction

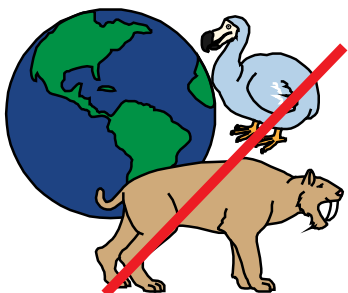

pollution

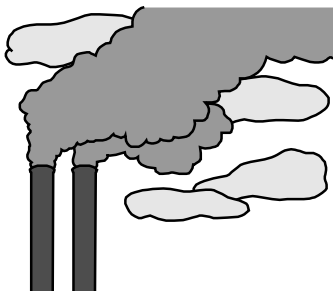

evolution

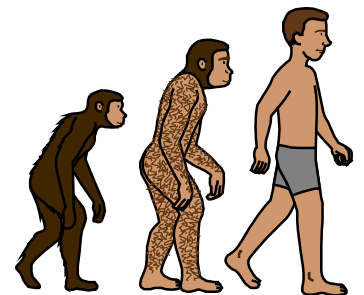

SCIENCE
Grade 11 Training
Test
Item 10

SCIENCE
Grade 11 Training
Test
Item 10

SCIENCE
Grade 11 Training
Test
Item 10

SCIENCE
Grade 11 Training
Test
Item 10

SCIENCE
Grade 11 Training
Test
Item 10

SCIENCE
Grade 11 Training
Test
Item 10

SCIENCE
Grade 11 Training
Test
Item 10

SCIENCE
Grade 11 Training
Test
Item 10

SCIENCE
Grade 11 Training
Test
Item 10

forest



snowy

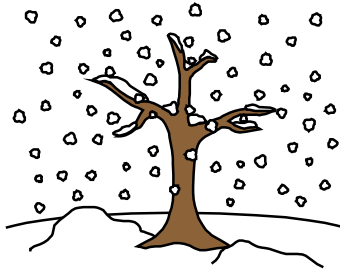

desert



forest



snowy

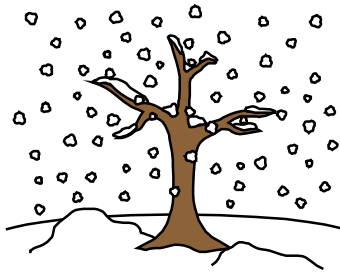

desert



forest



snowy



desert



SCIENCE
Grade 11 Training
Test
Item 11

SCIENCE
Grade 11 Training
Test
Item 11

SCIENCE
Grade 11 Training
Test
Item 11

SCIENCE
Grade 11 Training
Test
Item 11

SCIENCE
Grade 11 Training
Test
Item 11

SCIENCE
Grade 11 Training
Test
Item 11

SCIENCE
Grade 11 Training
Test
Item 11

SCIENCE
Grade 11 Training
Test
Item 11

SCIENCE
Grade 11 Training
Test
Item 11

swim



run



hide

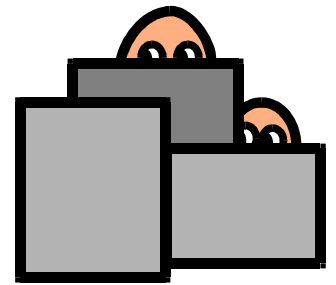

swim



run



hide

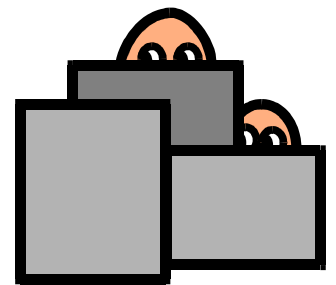

swim

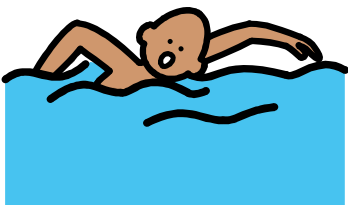

run



hide

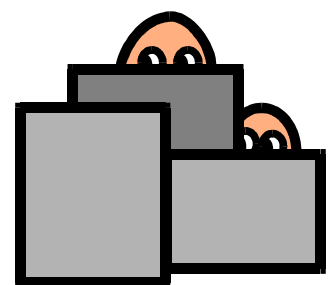

SCIENCE
Grade 11 Training
Test
Item 12

SCIENCE
Grade 11 Training
Test
Item 12

SCIENCE
Grade 11 Training
Test
Item 12

SCIENCE
Grade 11 Training
Test
Item 12

SCIENCE
Grade 11 Training
Test
Item 12

SCIENCE
Grade 11 Training
Test
Item 12

SCIENCE
Grade 11 Training
Test
Item 12

SCIENCE
Grade 11 Training
Test
Item 12

SCIENCE
Grade 11 Training
Test
Item 12

forest



snowy

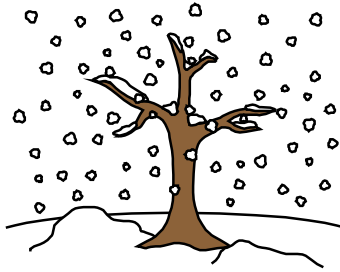

desert



forest



snowy

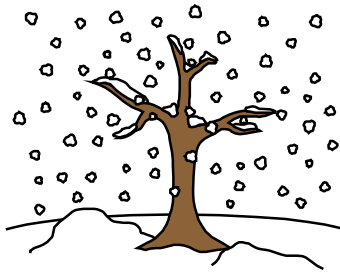

desert



forest



snowy

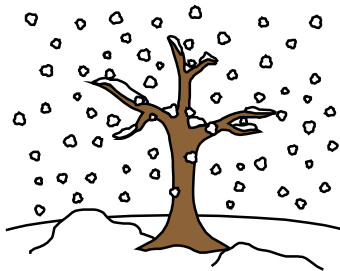

desert



SCIENCE
Grade 11 Training
Test
Item 13

SCIENCE
Grade 11 Training
Test
Item 13

SCIENCE
Grade 11 Training
Test
Item 13

SCIENCE
Grade 11 Training
Test
Item 13

SCIENCE
Grade 11 Training
Test
Item 13

SCIENCE
Grade 11 Training
Test
Item 13

SCIENCE
Grade 11 Training
Test
Item 13

SCIENCE
Grade 11 Training
Test
Item 13

SCIENCE
Grade 11 Training
Test
Item 13

water

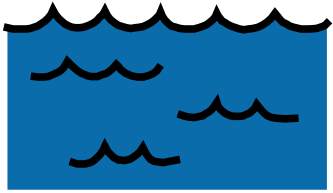

sand

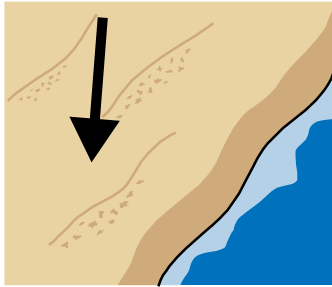

cold



water

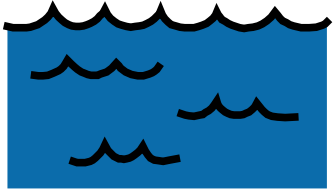

sand

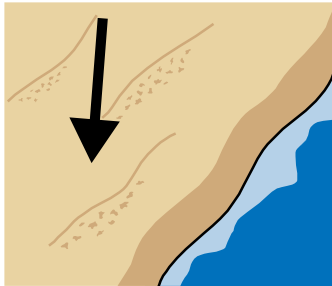

cold



water

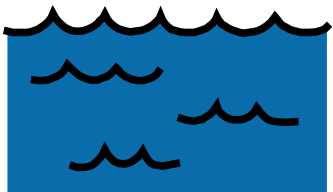

sand

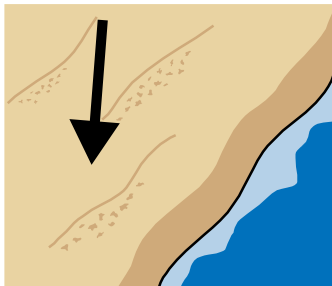

cold



SCIENCE
Grade 11 Training
Test
Item 14

SCIENCE
Grade 11 Training
Test
Item 14

SCIENCE
Grade 11 Training
Test
Item 14

SCIENCE
Grade 11 Training
Test
Item 14

SCIENCE
Grade 11 Training
Test
Item 14

SCIENCE
Grade 11 Training
Test
Item 14

SCIENCE
Grade 11 Training
Test
Item 14

SCIENCE
Grade 11 Training
Test
Item 14

SCIENCE
Grade 11 Training
Test
Item 14

forest



snowy

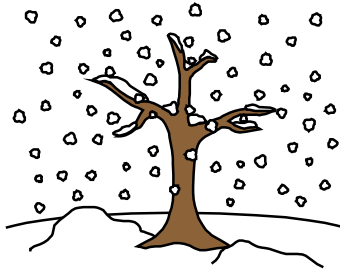

desert



forest



snowy

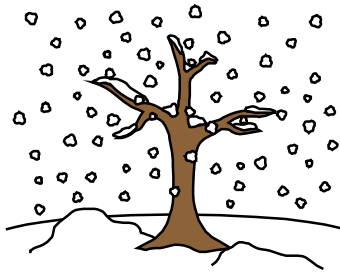

desert



forest



snowy



desert



SCIENCE
Grade 11 Training
Test
Item 15

SCIENCE
Grade 11 Training
Test
Item 15

SCIENCE
Grade 11 Training
Test
Item 15

SCIENCE
Grade 11 Training
Test
Item 15

SCIENCE
Grade 11 Training
Test
Item 15

SCIENCE
Grade 11 Training
Test
Item 15

SCIENCE
Grade 11 Training
Test
Item 15

SCIENCE
Grade 11 Training
Test
Item 15

SCIENCE
Grade 11 Training
Test
Item 15

communicate

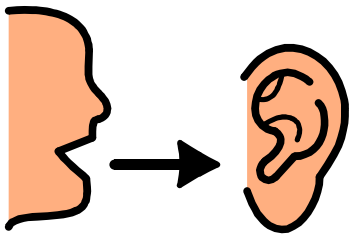

hide

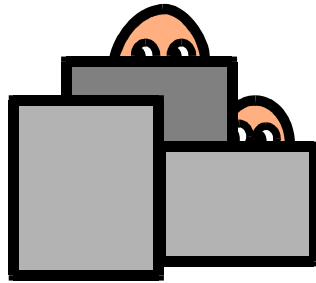

play

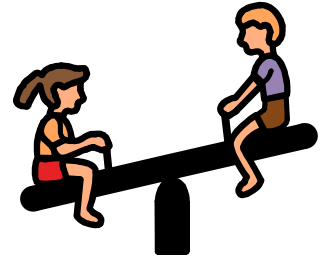

communicate

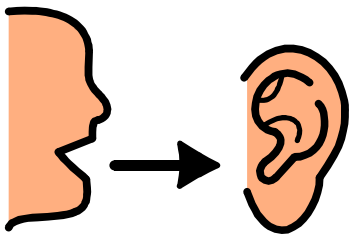

hide

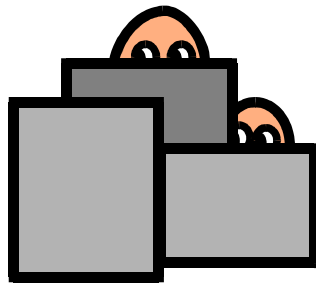

play

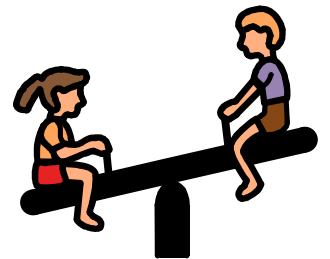

communicate

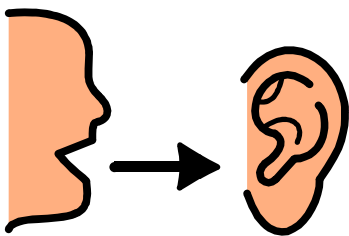

hide

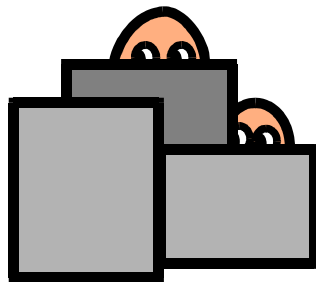

play

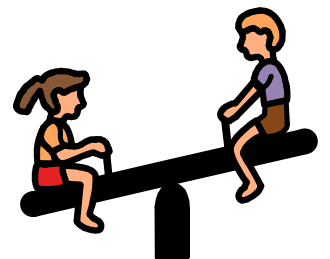

SCIENCE
Grade 11 Training
Test
Item 16

SCIENCE
Grade 11 Training
Test
Item 16

SCIENCE
Grade 11 Training
Test
Item 16

SCIENCE
Grade 11 Training
Test
Item 16

SCIENCE
Grade 11 Training
Test
Item 16

SCIENCE
Grade 11 Training
Test
Item 16

SCIENCE
Grade 11 Training
Test
Item 16

SCIENCE
Grade 11 Training
Test
Item 16

SCIENCE
Grade 11 Training
Test
Item 16

more

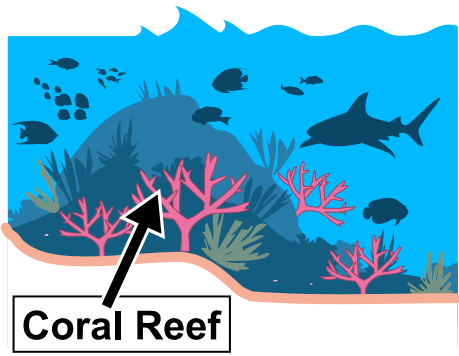

less

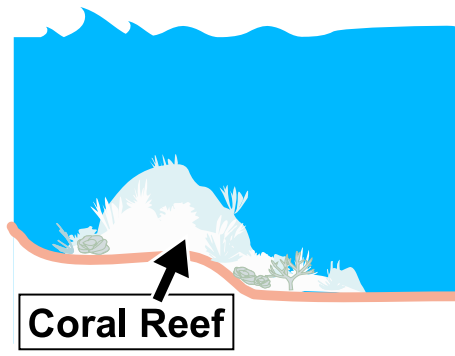

same

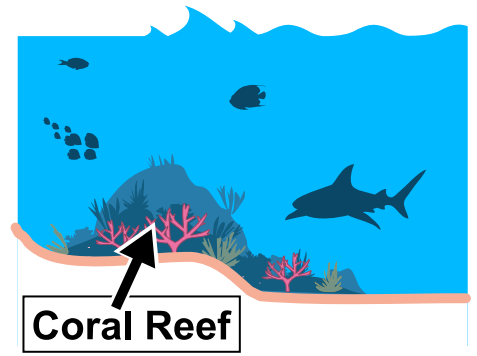

more

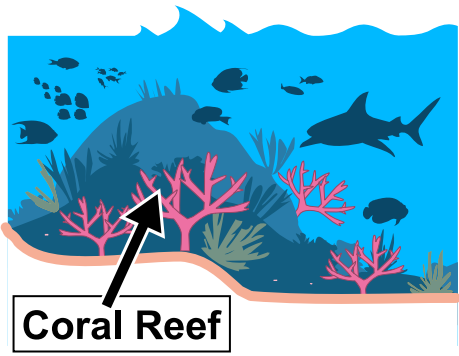

less

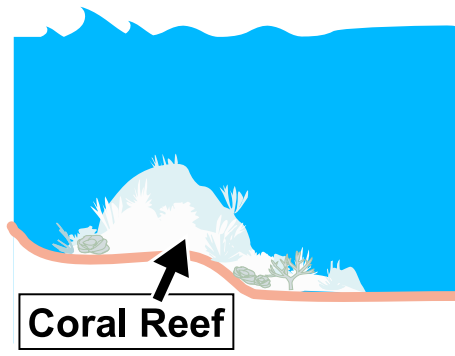

same

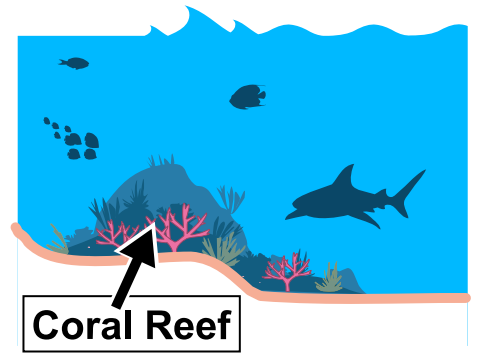

more

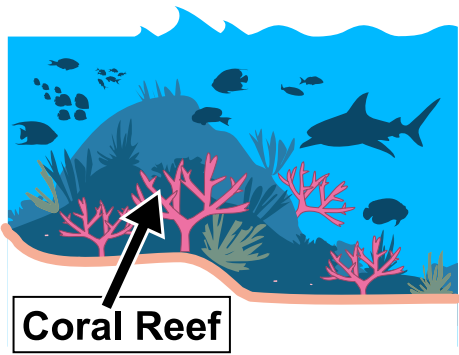

less

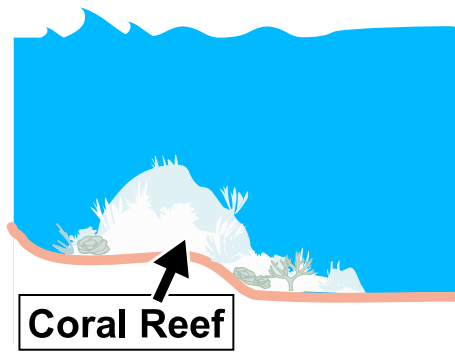

same

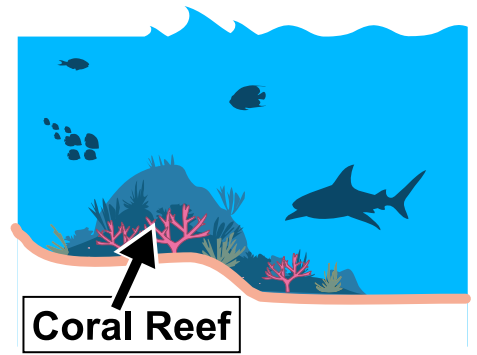

SCIENCE
Grade 11 Training
Test
Item 18

SCIENCE
Grade 11 Training
Test
Item 18

SCIENCE
Grade 11 Training
Test
Item 18

SCIENCE
Grade 11 Training
Test
Item 18

SCIENCE
Grade 11 Training
Test
Item 18

SCIENCE
Grade 11 Training
Test
Item 18

SCIENCE
Grade 11 Training
Test
Item 18

SCIENCE
Grade 11 Training
Test
Item 18

SCIENCE
Grade 11 Training
Test
Item 18

remove



sort

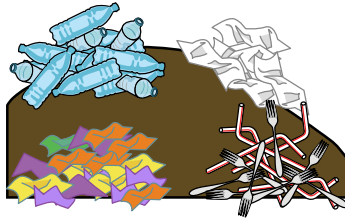

spread

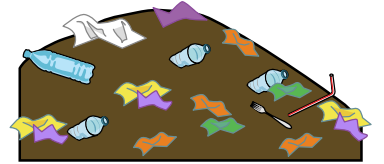

remove



sort

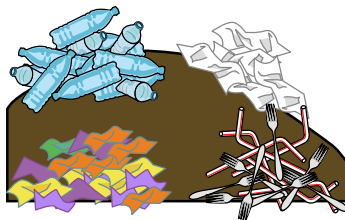

spread

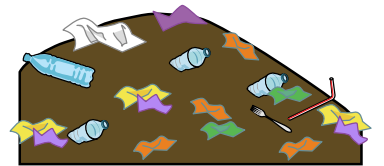

remove



sort

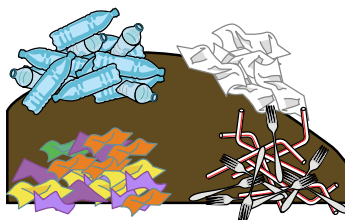

spread

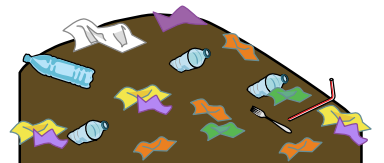

SCIENCE
Grade 11 Training
Test
Item 19

SCIENCE
Grade 11 Training
Test
Item 19

SCIENCE
Grade 11 Training
Test
Item 19

SCIENCE
Grade 11 Training
Test
Item 19

SCIENCE
Grade 11 Training
Test
Item 19

SCIENCE
Grade 11 Training
Test
Item 19

SCIENCE
Grade 11 Training
Test
Item 19

SCIENCE
Grade 11 Training
Test
Item 19

SCIENCE
Grade 11 Training
Test
Item 19

**Paper Response
Option Sentence Strips**

Science

The caterpillars help the trees.



The caterpillars hurt the trees.



The caterpillars avoid the trees.



SCIENCE
Grade 11 Training Test
Item 2

SCIENCE
Grade 11 Training Test
Item 2

SCIENCE
Grade 11 Training Test
Item 2

hiking more often through forests



protecting more natural forests



creating more farms from forests



SCIENCE
Grade 11 Training Test
Item 5

SCIENCE
Grade 11 Training Test
Item 5

SCIENCE
Grade 11 Training Test
Item 5

Step 1



Step 2



Step 3



SCIENCE
Grade 11 Training Test
Item 6

SCIENCE
Grade 11 Training Test
Item 6

SCIENCE
Grade 11 Training Test
Item 6

1950



1990



2017



SCIENCE
Grade 11 Training Test
Item 8

SCIENCE
Grade 11 Training Test
Item 8

SCIENCE
Grade 11 Training Test
Item 8

Paper Test Visuals

Science

chromosome

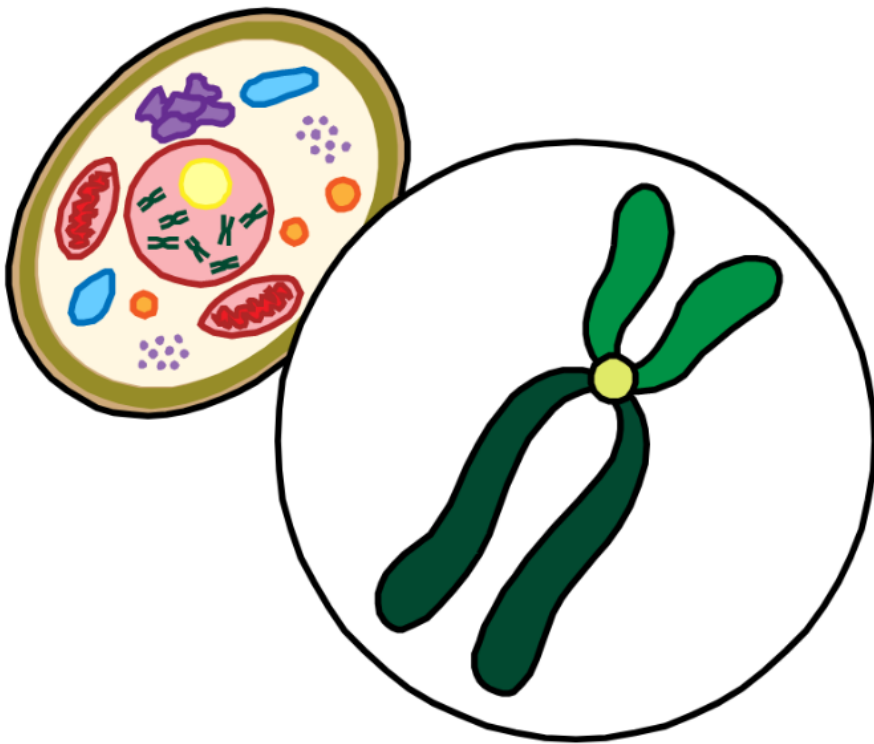

HSA-Alt Training Test
Science Grade 11
Item #1

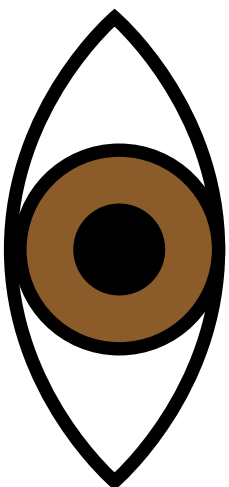

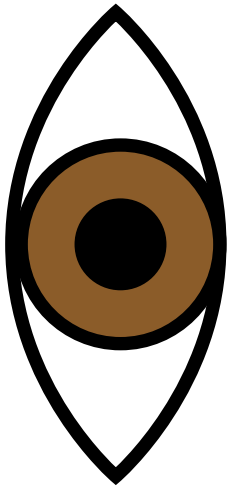

B

b

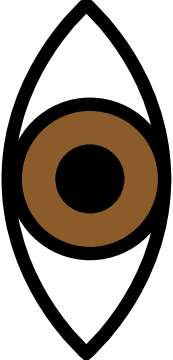

B

b

 BB	 Bb
?	 bb

HSA-Alt Training Test
Science Grade 11
Item #4

Human Activities and Carbon Dioxide

Activity	Carbon Dioxide
Hiking through forests	Stays the same
Protecting natural forests	Decreases
Changing forests to farmlands	Increases

HSA-Alt Training Test
Science Grade 11
Item #5

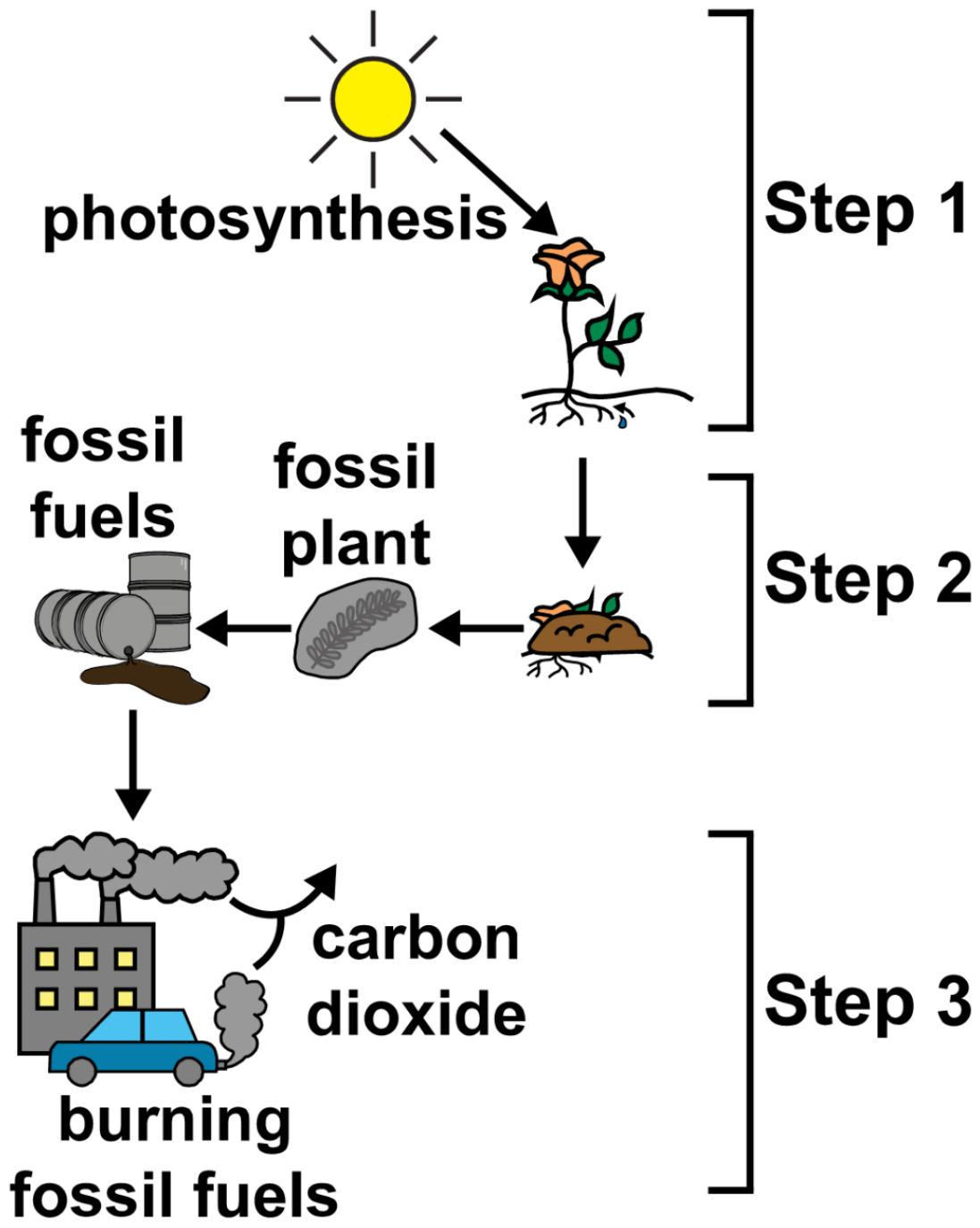

HSA-Alt Training Test
Science Grade 11
Item #6

Fish Population Over Time

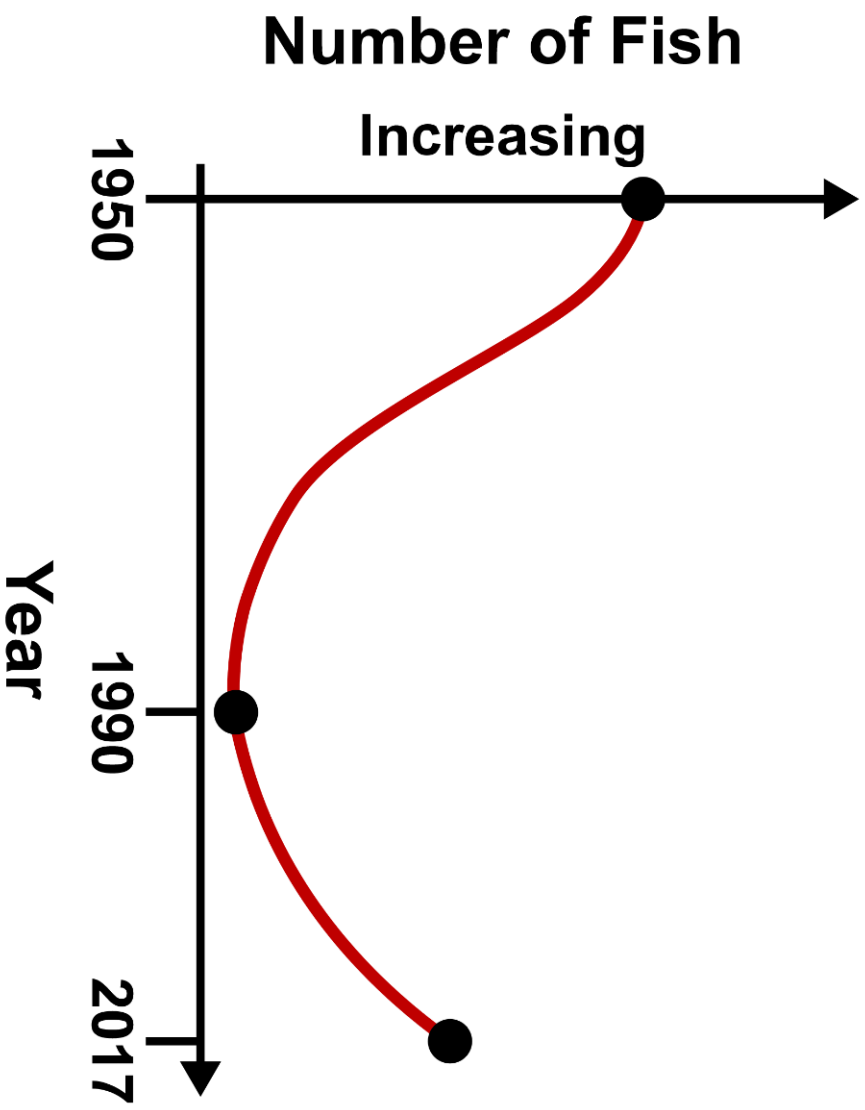

HSA-Alt Training Test
Science Grade 11
Item #8

Foxes

Types of Foxes	Adaptations
Arctic Fox	<ul style="list-style-type: none">● Has white fur in the winter● Has thick fur and layers of fat● Has fur on feet
Fennec Fox	<ul style="list-style-type: none">● Has sandy brown fur● Has large ears to release body heat● Has fur on feet
Gray Fox	<ul style="list-style-type: none">● Has gray fur● Has ability to climb trees and swim

HSA-Alt Training Test Science
Grade 11
Items #11, 12, 13, 14, 15, 16

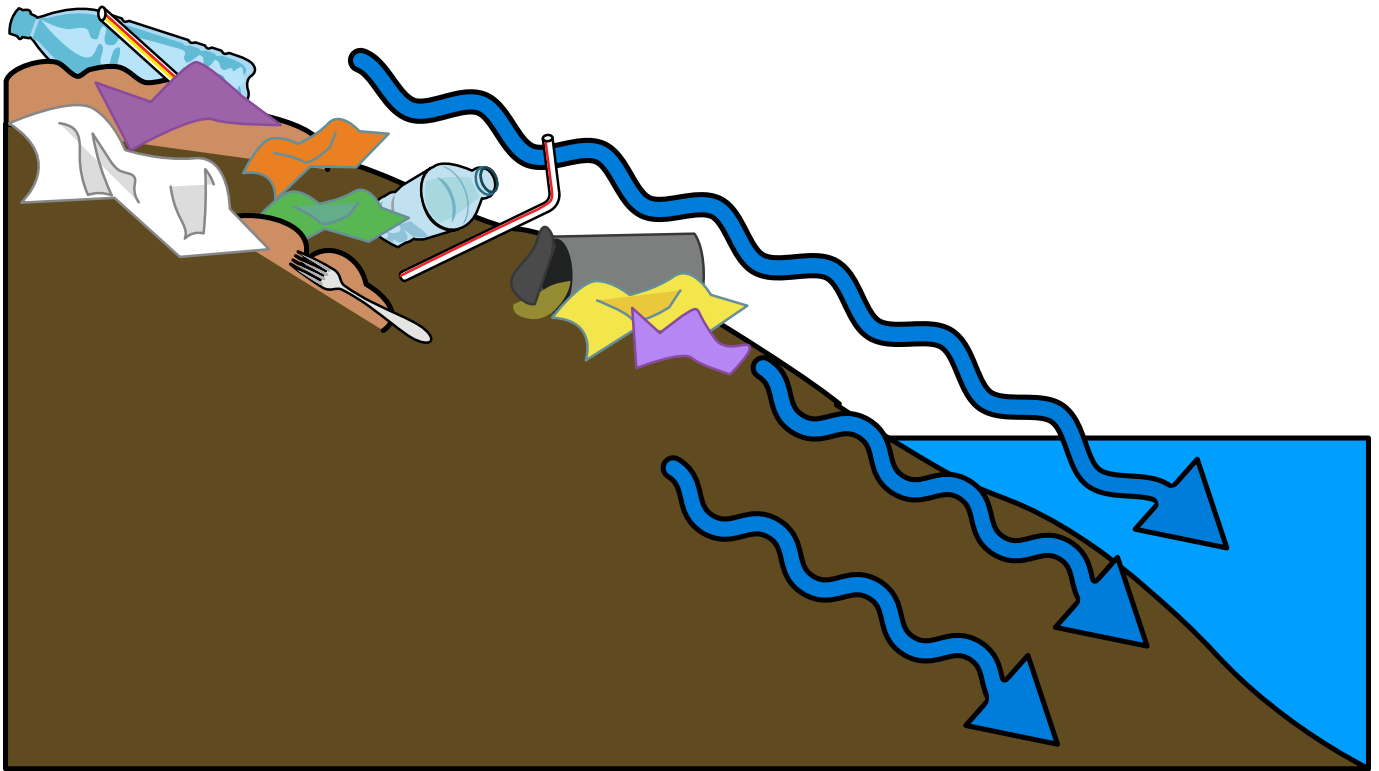

HSA-Alt Training Test
Science Grade 11
Item #19